

## GM 18/Ni

Locknut, brass nickel-plated, according to DIN 89280, M18

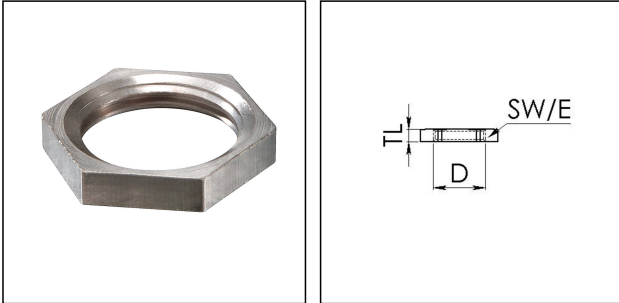

Products may differ in size, colour and appearance to those shown. If you require further information or customisation, please contact us directly.



|                                |                     |
|--------------------------------|---------------------|
| <b>Material</b>                | Brass nickel-plated |
| <b>Temp. range min</b>         | -150 °C             |
| <b>Temp. range max</b>         | 250 °C              |
| <b>Thread type</b>             | M                   |
| <b>Ø Connection thread D</b>   | 18                  |
| <b>Lead</b>                    | 1,5                 |
| <b>Key width SW</b>            | 22 mm               |
| <b>Collar diameter (E)</b>     | 25 mm               |
| <b>Total length TL</b>         | 4 mm                |
| <b>Surface</b>                 | Nickel-plated       |
| <b>Order no. nickel-plated</b> | 10012963            |
| <b>Type</b>                    | GM 18/Ni            |
| <b>Packing unit</b>            | 1                   |
| <b>ETIM-Classification</b>     | EC000940            |

23.05.2026

Your Contact:

**WISKA Hoppmann GmbH**

Kisdorfer Weg 28 · 24568 Kaltenkirchen · Germany

☎ +49-4191-508-0 · 📠 +49-4191-508-209

contact@wiska.de · www.wiska.com



Your Contact:

**WISKA Hoppmann GmbH**

Kisdorfer Weg 28 · 24568 Kaltenkirchen · Germany

☎ +49-4191-508-0 · 📠 +49-4191-508-209

contact@wiska.de · www.wiska.com