

COMBI 607/5 WH

Junction box 110x110x66mm, polypropylene, RAL 9001, with terminal block

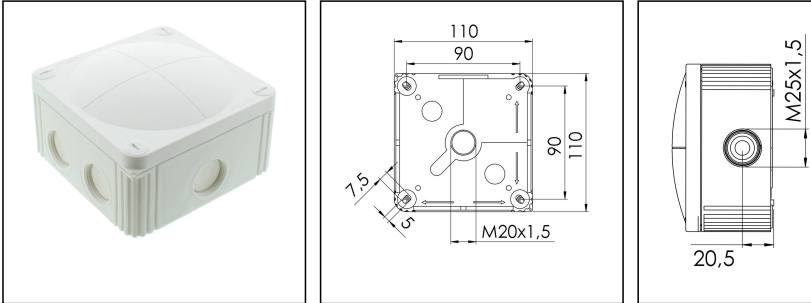

Products may differ in size, colour and appearance to those shown. If you require further information or customisation, please contact us directly.

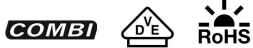

Material	Polypropylene
Material sealing gasket	TPE
Temp. range min	-30 °C
Temp. range max	100 °C
Temperatures during install.	-5 °C - 60 °C
Protection class	IP66 / IP67
Glow wire test	750 °C
Voltage	690 V
Rated current / A (Terminal)	41 A
Rated cross section	6 mm ²
Terminals/poles	5-pole, 6,0 mm ²
Fixing	4 internal openings
Ø cable diameter min	5,2 mm
Ø cable diameter max	17 mm
External dimensions LxWxH	110 x 110 x 66mm
Using for cable gland	
Product Color	RAL 9001
WISKA-Order no.	10060534
Type	COMBI 607/5 WH
Packing unit	3
ETIM-Classification	EC002600
EAN number	4007685605342
Tariff number	85369010

Remarks:

Your Contact:

WISKA Hoppmann GmbH

Kisdorfer Weg 28 · 24568 Kaltenkirchen · Germany

☎ +49-4191-508-0 · 📠 +49-4191-508-209

contact@wiska.de · www.wiska.com

IP66: using the membrane entry

IP67: using the threaded entry together with ESKV cable gland

Equipment:

- 7 M25 threaded membrane entries
- 3 membrane cable entries through rear
- 4 captive cover screws
- inclusive terminal block 5-pole, 6mm²

Mounting:

- 4 internal openings outside of the sealing area

Recommended accessories

MP-L Mounting plate large COMBI / WHK	10105775
External mounting - COMBI LG	10108836

Spare parts

SP-HKT 607 Terminal block	22000407
----------------------------------	----------

23.05.2026

Your Contact:

WISKA Hoppmann GmbH

Kisdorfer Weg 28 · 24568 Kaltenkirchen · Germany

☎ +49-4191-508-0 · 📠 +49-4191-508-209

contact@wiska.de · www.wiska.com

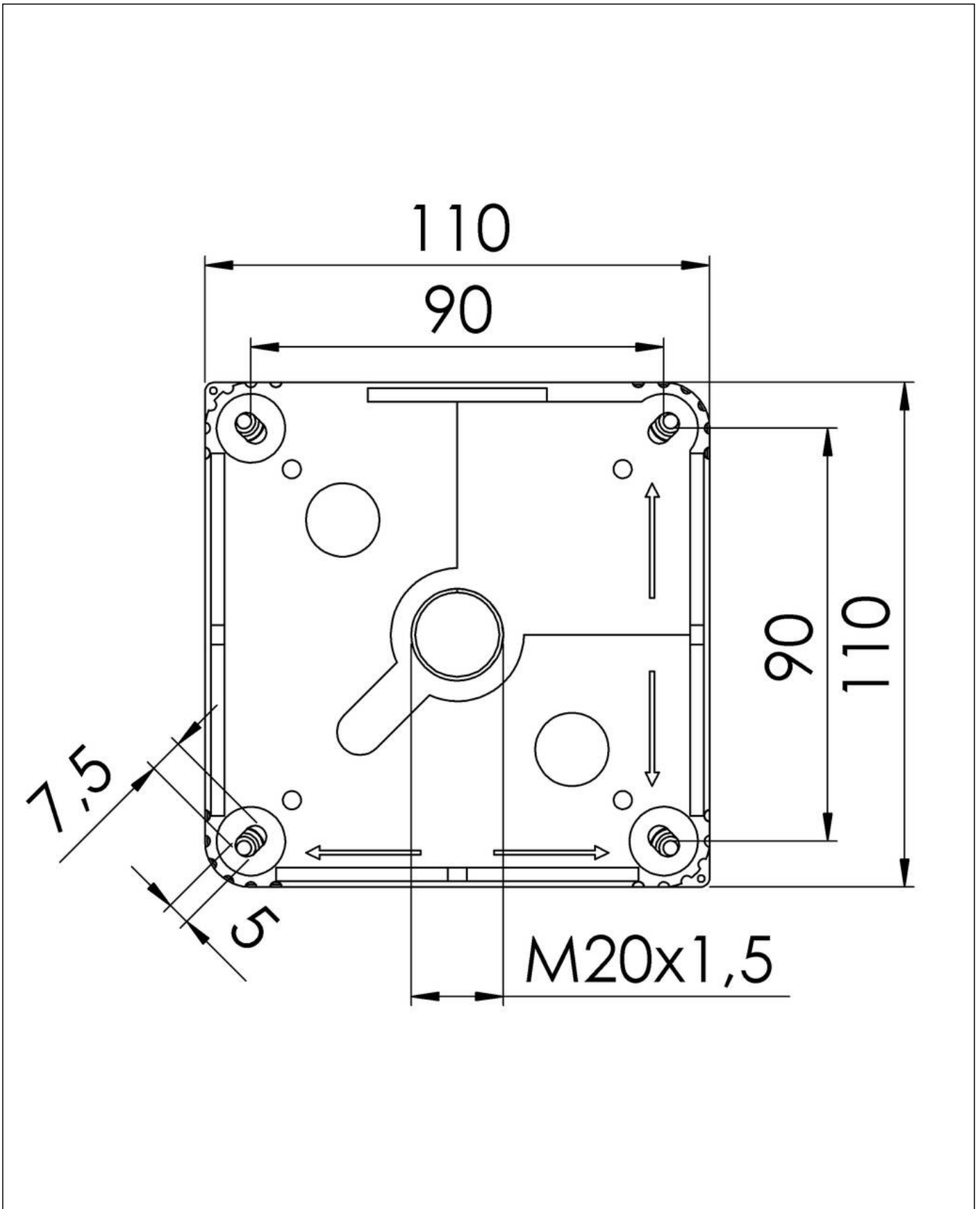

Your Contact:

WISKA Hoppmann GmbH

Kisdorfer Weg 28 · 24568 Kaltenkirchen · Germany

☎ +49-4191-508-0 · 📠 +49-4191-508-209

contact@wiska.de · www.wiska.com



Your Contact:

WISKA Hoppmann GmbH

Kisdorfer Weg 28 · 24568 Kaltenkirchen · Germany

☎ +49-4191-508-0 · 📠 +49-4191-508-209

contact@wiska.de · www.wiska.com