

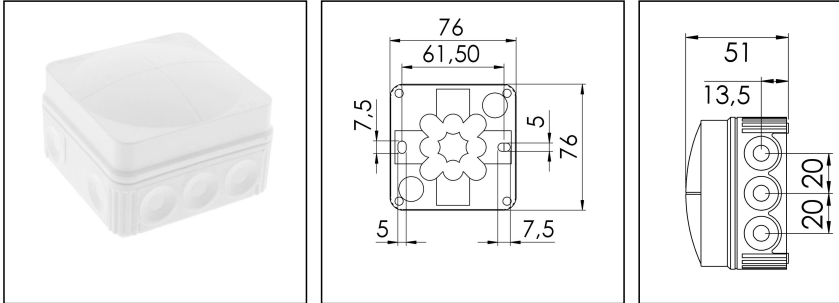

COMBI 108/5 WH

Junction box 76x76x51mm, polypropylene, RAL 9001, inclusive terminal block



Products may differ in size, colour and appearance to those shown. If you require further information or customisation, please contact us directly.



Material	Polypropylene
Material sealing gasket	TPE
Temp. range min	-30 °C
Temp. range max	100 °C
Temperatures during install.	-5 °C - 60 °C
Protection class	IP66
Glow wire test	750 °C
Voltage	400 V
Rated current / A (Terminal)	24 A
Rated cross section	2,5 mm ²
Terminals/poles	5-pole, 2,5mm ²
Fixing	2 internal openings
Ø cable diameter min	3 mm
Ø cable diameter max	14 mm
External dimensions LxWxH	76 x 76 x 51mm
Using for cable gland	
Product Color	RAL 9001
WISKA-Order no.	10060623
Type	COMBI 108/5 WH
Packing unit	10
ETIM-Classification	EC002600
EAN number	4007685606233
Tariff number	85369010

Remarks:

Your Contact:

WISKA Hoppmann GmbH
Kisdorfer Weg 28 · 24568 Kaltenkirchen · Germany
☎ +49-4191-508-0 · 📠 +49-4191-508-209
contact@wiska.de · www.wiska.com

Equipment:

- 10 elastic self-sealing puncture-membranes for cable entry on the side and 2 in the bottom
- inclusive terminal block 5-poles, 2,5mm²

Fixing:

By two internal openings outside of the sealing area

Recommended accessories

MP-S Mounting plate small	10105774
MP-L Mounting plate large COMBI / WHK	10105775
ZER 4-12 LG	10109800
ZER 11-18 LG	10110766

Spare parts

SP-HKT 11/5 Terminal block	22001132
----------------------------	----------

23.05.2026

Your Contact:

WISKA Hoppmann GmbH

Kisdorfer Weg 28 · 24568 Kaltenkirchen · Germany

☎ +49-4191-508-0 · 📠 +49-4191-508-209

contact@wiska.de · www.wiska.com

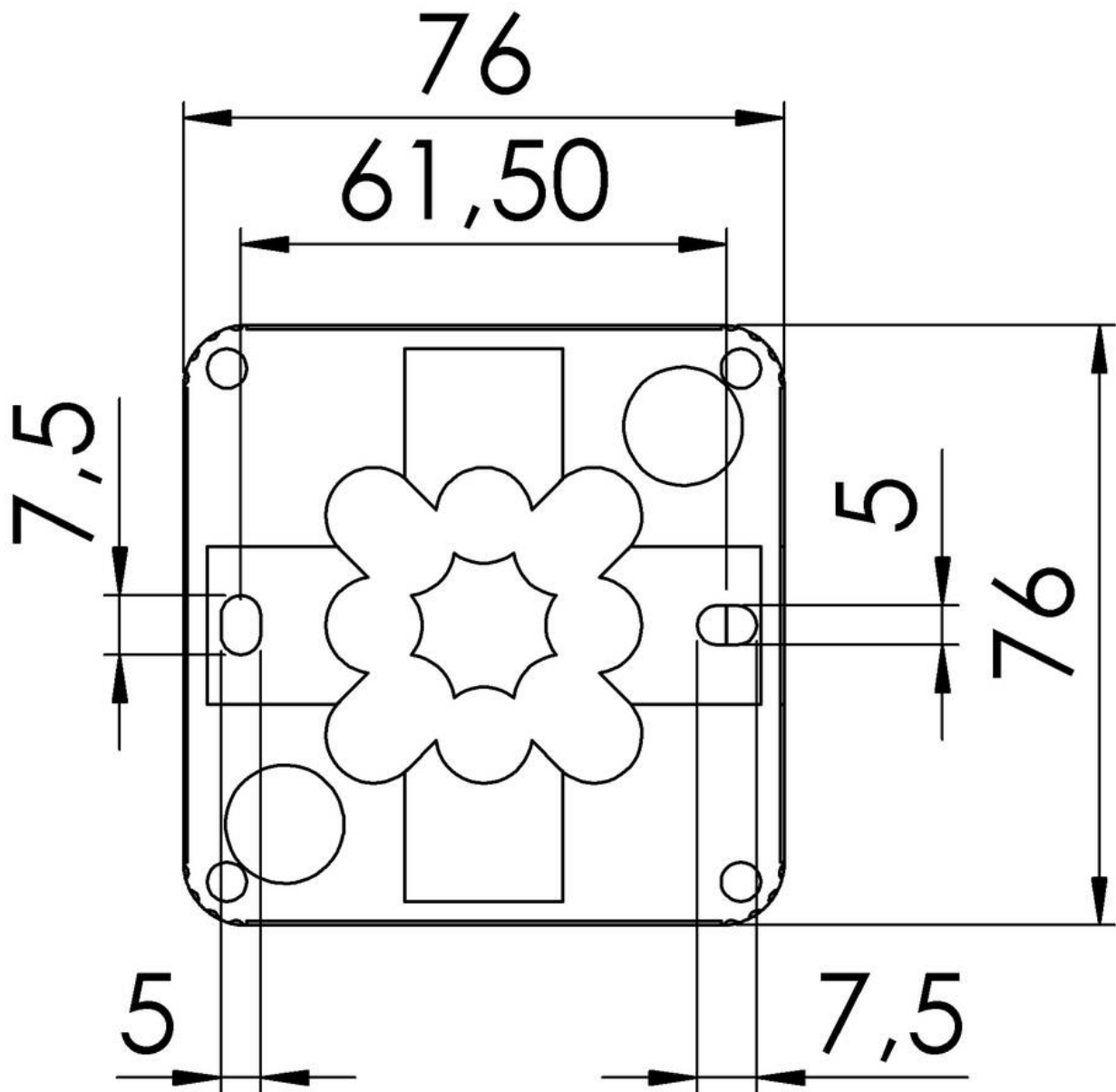

Your Contact:

WISKA Hoppmann GmbH

Kisdorfer Weg 28 · 24568 Kaltenkirchen · Germany

☎ +49-4191-508-0 · 📠 +49-4191-508-209

contact@wiska.de · www.wiska.com

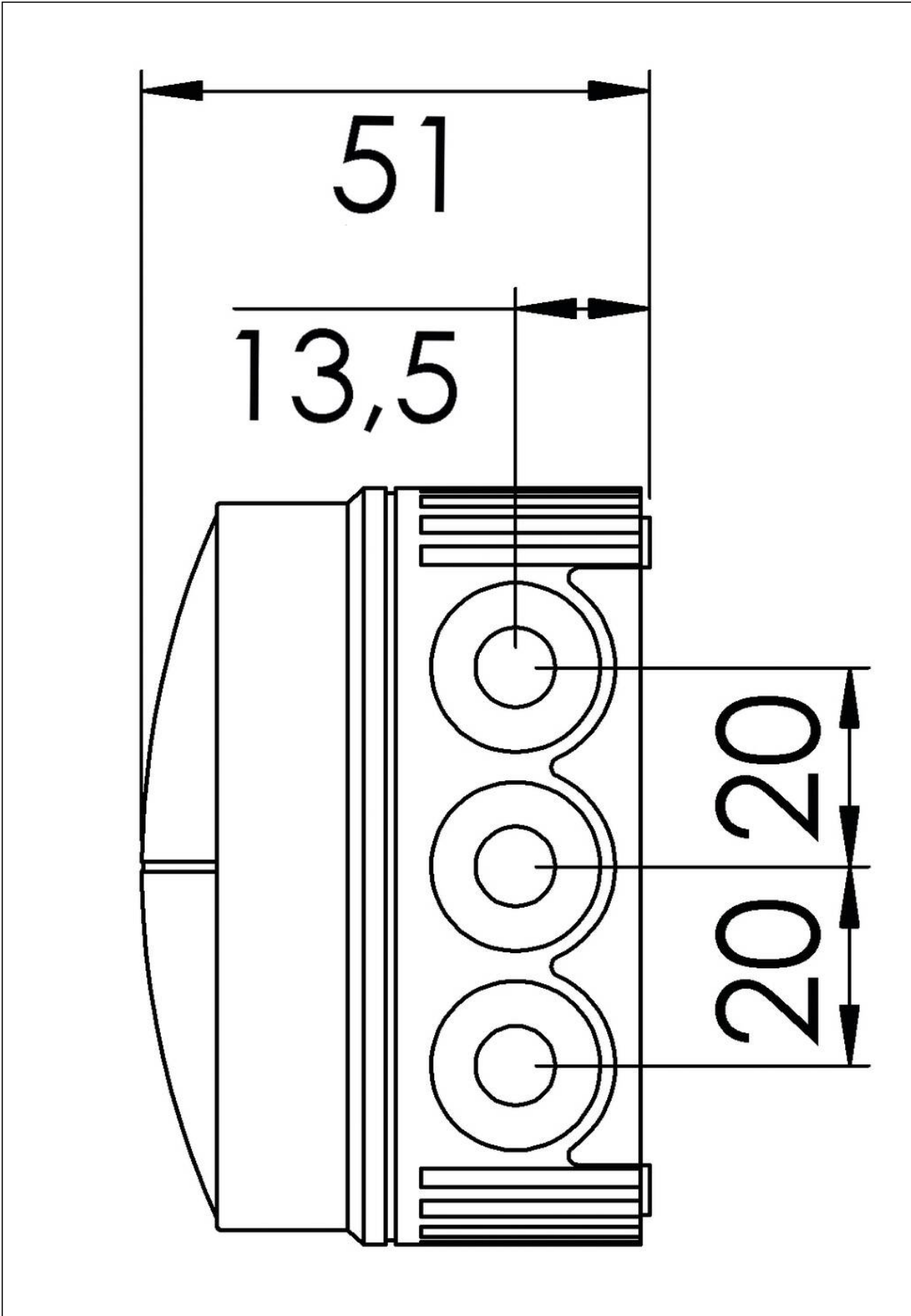

Your Contact:

WISKA Hoppmann GmbH

Kisdorfer Weg 28 · 24568 Kaltenkirchen · Germany

☎ +49-4191-508-0 · 📠 +49-4191-508-209

contact@wiska.de · www.wiska.com