

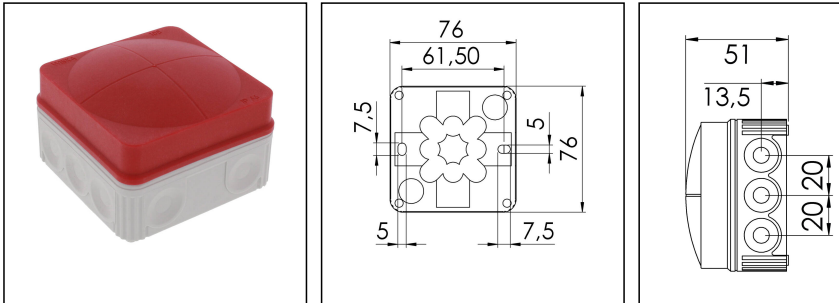

COMBI 108 LG RD

Junction box 76x76x51mm, polypropylene, RAL 7035, cover RAL 3000



Products may differ in size, colour and appearance to those shown. If you require further information or customisation, please contact us directly.



Material	Polypropylene
Material sealing gasket	TPE
Temp. range min	-30 °C
Temp. range max	100 °C
Temperatures during install.	-5 °C - 60 °C
Protection class	IP66
Glow wire test	750 °C
Voltage	400 V
Rated cross section	2,5 mm ²
Fixing	2 internal openings
Ø cable diameter min	3 mm
Ø cable diameter max	14 mm
External dimensions LxWxH	76 x 76 x 51mm
Using for cable gland	
Product Color	RAL 7035 / RAL 3000
WISKA-Order no.	10060632
Type	COMBI 108 LG RD
Packing unit	10
ETIM-Classification	EC002600
EAN number	4007685606325
Tariff number	39269097

Remarks:

Equipment:

- 10 elastic self-sealing puncture-membranes for cable entry on the side and 2 in the bottom

Your Contact:

WISKA Hoppmann GmbH

Kisdorfer Weg 28 · 24568 Kaltenkirchen · Germany

☎ +49-4191-508-0 · 📠 +49-4191-508-209

contact@wiska.de · www.wiska.com

- Color casing: RAL 7035 (grey)
- Color lid: RAL 3000 (red)

Fixing:

By two internal openings outside of the sealing area

Recommended accessories

DIN Rail Kit - COMBI 108/308/TS15	10060362
MP-S Mounting plate small	10105774
MP-L Mounting plate large COMBI / WHK	10105775
ZER 4-12 LG	10109800
ZER 11-18 LG	10110766
SP-KT-W 221/CSM-3x221-413	22001114
SP-KT-W 221/CSM	22001115
SP-HKT 11/5 Terminal block	22001132

23.05.2026

Your Contact:

WISKA Hoppmann GmbH

Kisdorfer Weg 28 · 24568 Kaltenkirchen · Germany

☎ +49-4191-508-0 · 📠 +49-4191-508-209

contact@wiska.de · www.wiska.com

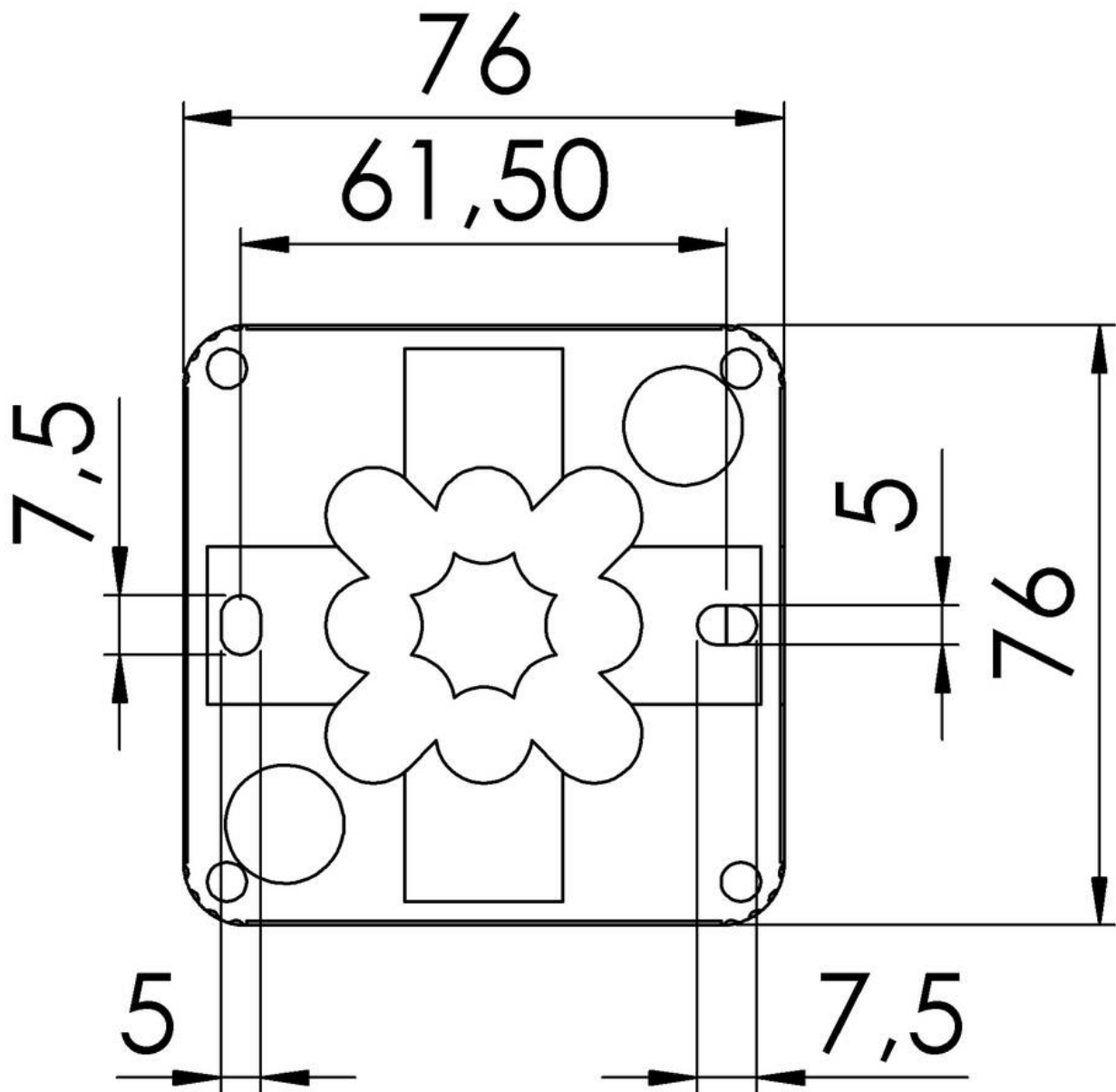

Your Contact:

WISKA Hoppmann GmbH

Kisdorfer Weg 28 · 24568 Kaltenkirchen · Germany

☎ +49-4191-508-0 · 📠 +49-4191-508-209

contact@wiska.de · www.wiska.com

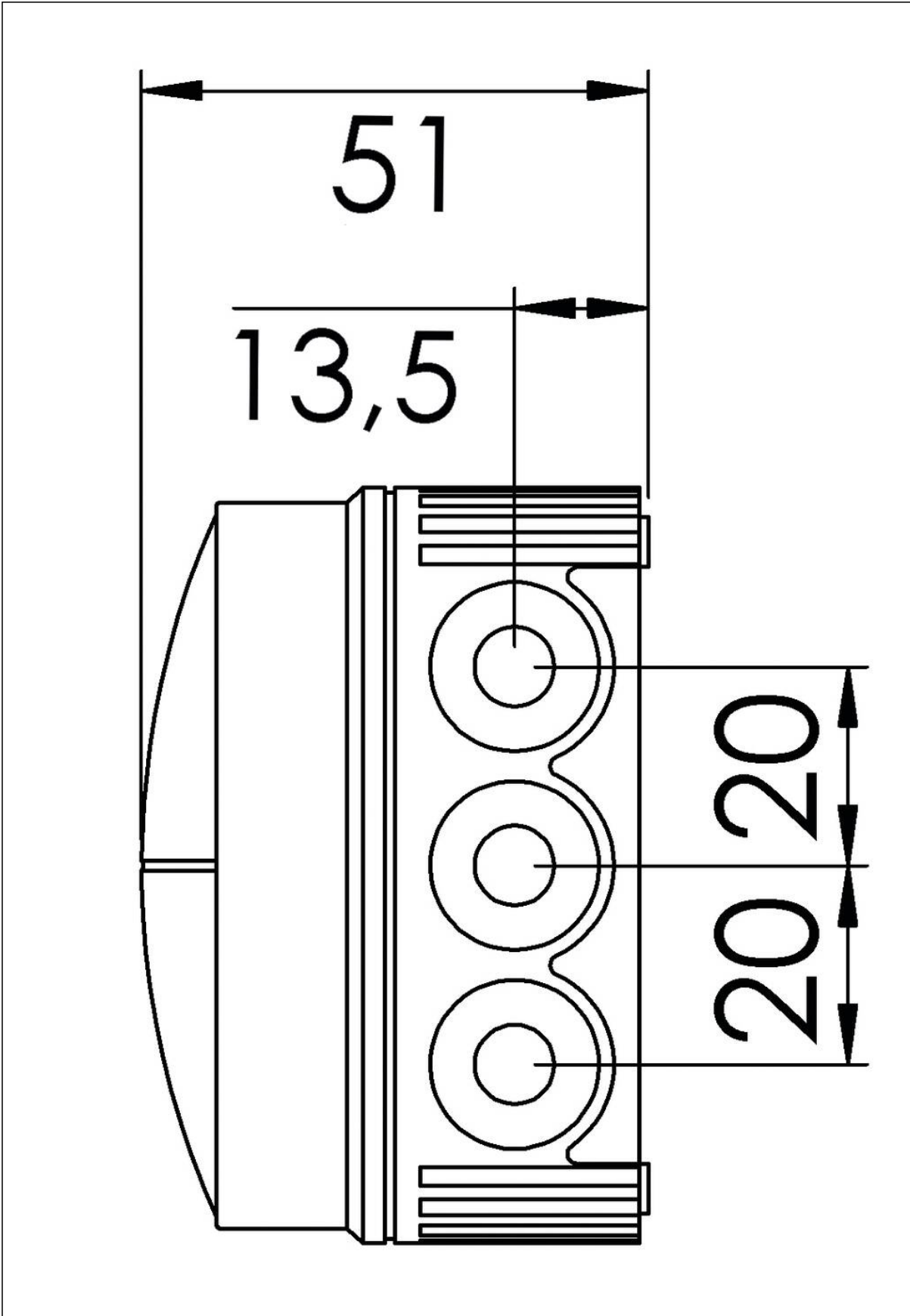

Your Contact:
WISKA Hoppmann GmbH
Kisdorfer Weg 28 · 24568 Kaltenkirchen · Germany
☎ +49-4191-508-0 · 📠 +49-4191-508-209
contact@wiska.de · www.wiska.com