

ESVG 20 LG

Pressure compensation cable gland, polyamide, RAL 7035, M20

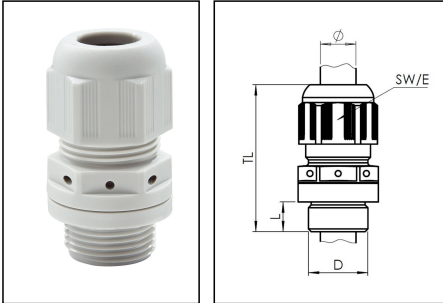

Products may differ in size, colour and appearance to those shown. If you require further information or customisation, please contact us directly.



Material cable gland	Polyamide
Material membrane	ePTFE
Material sealing gasket	EPDM
Airflow at 70mbar	42 l/h
Temp. range min	-40 °C
Temp. range max	100 °C
Glow wire test	750 °C
Protection class	IP68 / IP69
Thread type	M
Ø Connection thread D	20
Lead	1,5
Length screw-in thread L	10 mm
Ø cable diameter min	6 mm
Ø cable diameter max	13 mm
Key width SW	24 mm
Collar diameter (E)	27 mm
Install. torques fitting	2,3 N m
Install. torques cap nut	1,5 N m
Total length TL	41 mm - 50 mm
Equipment	Incl. connection thread gasket
Product Color	RAL 7035
Order no. RAL 7035	10060974
Type	ESVG 20 LG
Packing unit	1
EAN number	4007685609746

Your Contact:

WISKA Hoppmann GmbH

Kisdorfer Weg 28 · 24568 Kaltenkirchen · Germany

☎ +49-4191-508-0 · 📠 +49-4191-508-209

contact@wiska.de · www.wiska.com

Tariff number	39269097
ETIM-Classification	EC000441

Recommended accessories

EMUG 20 LG	10060772
MFD 20/02/065	10060953
RDE 20	10062185
BS 13	10064010
MFD 20/03/040	10064341
MFD 20/02/060	10064395
MFD 20/03/045	10102306

26.06.2026

Your Contact:

WISKA Hoppmann GmbH

Kisdorfer Weg 28 · 24568 Kaltenkirchen · Germany

☎ +49-4191-508-0 · 📠 +49-4191-508-209

contact@wiska.de · www.wiska.com



Your Contact:

WISKA Hoppmann GmbH

Kisdorfer Weg 28 · 24568 Kaltenkirchen · Germany

☎ +49-4191-508-0 · 📠 +49-4191-508-209

contact@wiska.de · www.wiska.com