

ESKV-L 20 LT BK

Cable gland LowTemp, polyamide, M20, RAL 9005 with long thread

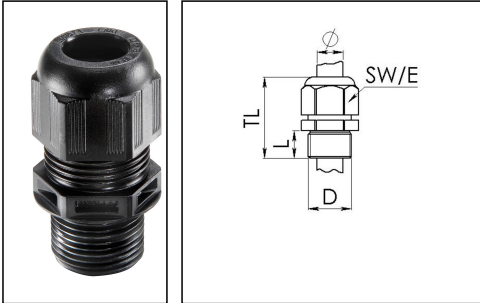

Products may differ in size, colour and appearance to those shown. If you require further information or customisation, please contact us directly.



Material cable gland	Polyamide
Material sealing gasket	Silicone
Protection class	IP68 (5 bar 30 min), IP69
Temp. range min	-60 °C
Temp. range max	100 °C
Glow wire test	750 °C
Thread type	M
Ø Connection thread D	20
Lead	1,5
Length screw-in thread L	15 mm
Ø cable diameter min	6 mm
Ø cable diameter max	13 mm
Key width SW	24 mm
Collar diameter (E)	27 mm
Total length TL	41 mm - 50 mm
Type of cable anchorage	A
Install. torques fitting	4 N m
Install. torques fitting/EADR	3 N m
Install. torques cap nut	3 N m
Impact category	3
Product Color	RAL 9005
Type	ESKV-L 20 LT BK
Order no. RAL 9005	10061868
Packing unit	50
EAN number	4007685618687

Your Contact:

WISKA Hoppmann GmbH

Kisdorfer Weg 28 · 24568 Kaltenkirchen · Germany

☎ +49-4191-508-0 · 📠 +49-4191-508-209

contact@wiska.de · www.wiska.com

Tariff number	39269097
ETIM-Classification	EC000441

Recommended accessories

RDE 20 LT	10063909
BS 13	10064010
EADR 20/90 LT	10105706

23.05.2026

Your Contact:

WISKA Hoppmann GmbH

Kisdorfer Weg 28 · 24568 Kaltenkirchen · Germany

☎ +49-4191-508-0 · 📠 +49-4191-508-209

contact@wiska.de · www.wiska.com



Your Contact:

WISKA Hoppmann GmbH

Kisdorfer Weg 28 · 24568 Kaltenkirchen · Germany

☎ +49-4191-508-0 · 📠 +49-4191-508-209

contact@wiska.de · www.wiska.com