

ESKV 12 LT SG

Cable gland LowTemp, polyamide, M12, RAL 7001 with short thread

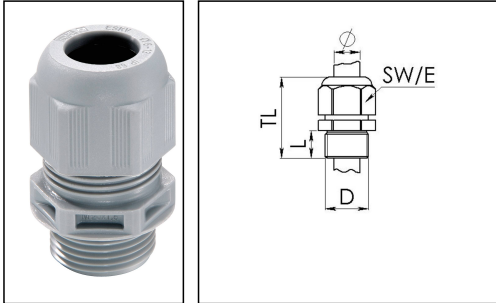

Products may differ in size, colour and appearance to those shown. If you require further information or customisation, please contact us directly.



Material cable gland	Polyamide
Material sealing gasket	Silicone
Protection class	IP69, IP68 (5 bar 30 min)
Temp. range min	-60 °C
Temp. range max	100 °C
Glow wire test	750 °C
Thread type	M
Ø Connection thread D	12
Lead	1,5
Length screw-in thread L	9 mm
Ø cable diameter min	3 mm
Ø cable diameter max	7 mm
Key width SW	16 mm
Collar diameter (E)	18 mm
Total length TL	29 mm - 34 mm
Type of cable anchorage	A
Install. torques fitting	2 N m
Install. torques fitting/EADR	2 N m
Install. torques cap nut	2 N m
Impact category	2
Product Color	RAL 7001
Type	ESKV 12 LT SG
Order no. RAL 7001	10061917
Packing unit	50
EAN number	4007685619172

Your Contact:

WISKA Hoppmann GmbH

Kisdorfer Weg 28 · 24568 Kaltenkirchen · Germany

☎ +49-4191-508-0 · 📠 +49-4191-508-209

contact@wiska.de · www.wiska.com

Tariff number	39269097
ETIM-Classification	EC000441

Recommended accessories

RDE 12 LT	10063981
BS 7	10064005
EADR 12/90 LT	10105704

23.05.2026

Your Contact:

WISKA Hoppmann GmbH

Kisdorfer Weg 28 · 24568 Kaltenkirchen · Germany

☎ +49-4191-508-0 · 📠 +49-4191-508-209

contact@wiska.de · www.wiska.com



Your Contact:

WISKA Hoppmann GmbH

Kisdorfer Weg 28 · 24568 Kaltenkirchen · Germany

☎ +49-4191-508-0 · 📠 +49-4191-508-209

contact@wiska.de · www.wiska.com