

ESKV-L 40 LT SG

Cable gland LowTemp, polyamide, M40, RAL 7001 with long thread

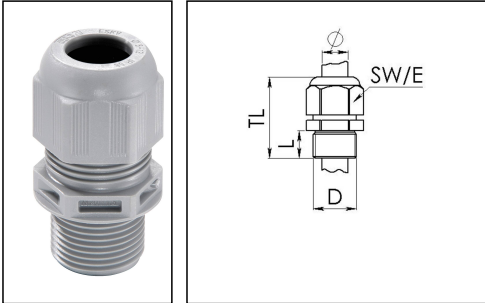

Products may differ in size, colour and appearance to those shown. If you require further information or customisation, please contact us directly.



Material cable gland	Polyamide
Material sealing gasket	Silicone
Protection class	IP69, IP68 (5 bar 30 min)
Temp. range min	-60 °C
Temp. range max	100 °C
Glow wire test	750 °C
Thread type	M
Ø Connection thread D	40
Lead	1,5
Length screw-in thread L	18 mm
Ø cable diameter min	16 mm
Ø cable diameter max	28 mm
Key width SW	46 mm
Collar diameter (E)	51 mm
Total length TL	58 mm - 71 mm
Type of cable anchorage	A
Install. torques fitting	20 N m
Install. torques cap nut	20 N m
Impact category	4
Equipment	Incl. connection thread gasket
Product Color	RAL 7001
Type	ESKV-L 40 LT SG
Order no. RAL 7001	10061951
Packing unit	10
EAN number	4007685619516

Your Contact:

WISKA Hoppmann GmbH

Kisdorfer Weg 28 · 24568 Kaltenkirchen · Germany

☎ +49-4191-508-0 · 📠 +49-4191-508-209

contact@wiska.de · www.wiska.com

Tariff number	39269097
ETIM-Classification	EC000441

Recommended accessories

RDE 40 LT	10063960
BS 28	10064016

23.05.2026

Your Contact:

WISKA Hoppmann GmbH

Kisdorfer Weg 28 · 24568 Kaltenkirchen · Germany

☎ +49-4191-508-0 · 📠 +49-4191-508-209

contact@wiska.de · www.wiska.com



Your Contact:

WISKA Hoppmann GmbH

Kisdorfer Weg 28 · 24568 Kaltenkirchen · Germany

☎ +49-4191-508-0 · 📠 +49-4191-508-209

contact@wiska.de · www.wiska.com