

## ESKV-L 12 LT LG

Cable gland LowTemp, polyamide, M12, RAL 7035 with long thread

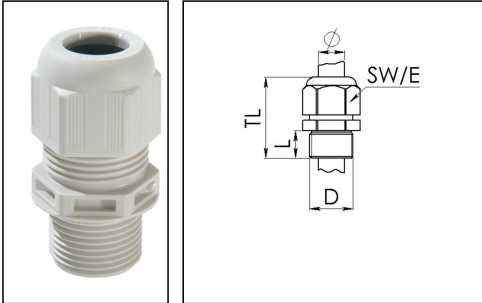

Products may differ in size, colour and appearance to those shown. If you require further information or customisation, please contact us directly.



<b>Material cable gland</b>	Polyamide
<b>Material sealing gasket</b>	Silicone
<b>Protection class</b>	IP69, IP68 (5 bar 30 min)
<b>Temp. range min</b>	-60 °C
<b>Temp. range max</b>	100 °C
<b>Glow wire test</b>	750 °C
<b>Thread type</b>	M
<b>Ø Connection thread D</b>	12
<b>Lead</b>	1,5
<b>Length screw-in thread L</b>	15 mm
<b>Ø cable diameter min</b>	3 mm
<b>Ø cable diameter max</b>	7 mm
<b>Key width SW</b>	16 mm
<b>Collar diameter (E)</b>	18 mm
<b>Total length TL</b>	35 mm - 40 mm
<b>Type of cable anchorage</b>	A
<b>Install. torques fitting</b>	2 N m
<b>Install. torques fitting/EADR</b>	2 N m
<b>Install. torques cap nut</b>	2 N m
<b>Impact category</b>	2
<b>Product Color</b>	RAL 7035
<b>Type</b>	ESKV-L 12 LT LG
<b>Order no. RAL 7035</b>	10062737
<b>Packing unit</b>	50
<b>EAN number</b>	4007685627375

Your Contact:

WISKA Hoppmann GmbH

Kisdorfer Weg 28 · 24568 Kaltenkirchen · Germany

☎ +49-4191-508-0 · 📠 +49-4191-508-209

contact@wiska.de · www.wiska.com

<b>Tariff number</b>	39269097
<b>ETIM-Classification</b>	EC000441

## Recommended accessories

<b>RDE 12 LT</b>	10063981
<b>BS 7</b>	10064005
<b>EADR 12/90 LT</b>	10105704

23.05.2026

Your Contact:

**WISKA Hoppmann GmbH**

Kisdorfer Weg 28 · 24568 Kaltenkirchen · Germany

☎ +49-4191-508-0 · 📠 +49-4191-508-209

contact@wiska.de · www.wiska.com



Your Contact:

**WISKA Hoppmann GmbH**

Kisdorfer Weg 28 · 24568 Kaltenkirchen · Germany

☎ +49-4191-508-0 · 📠 +49-4191-508-209

contact@wiska.de · www.wiska.com