

EMMU 25

Locknut, brass nickel-plated, M25

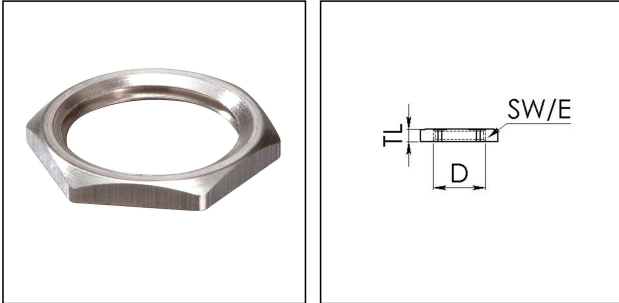

Products may differ in size, colour and appearance to those shown. If you require further information or customisation, please contact us directly.



Material	Brass nickel-plated
Surface	Nickel-plated
Temp. range min	-200 °C
Temp. range max	250 °C
Thread type	M
Ø Connection thread D	25
Lead	1,5
Key width SW	30 mm
Collar diameter (E)	34 mm
Total length TL	3,5 mm
Order no. nickel-plated	10063144
Type	EMMU 25
Packing unit	100
EAN number	4007685631440
Tariff number	74153300
ETIM-Classification	EC000940

23.05.2026

Your Contact:

WISKA Hoppmann GmbH

Kisdorfer Weg 28 · 24568 Kaltenkirchen · Germany

☎ +49-4191-508-0 · 📠 +49-4191-508-209

contact@wiska.de · www.wiska.com



Your Contact:

WISKA Hoppmann GmbH

Kisdorfer Weg 28 · 24568 Kaltenkirchen · Germany

☎ +49-4191-508-0 · 📠 +49-4191-508-209

contact@wiska.de · www.wiska.com