

MEM 25/32

Enlargement adaptor, brass nickel-plated, M25/M32

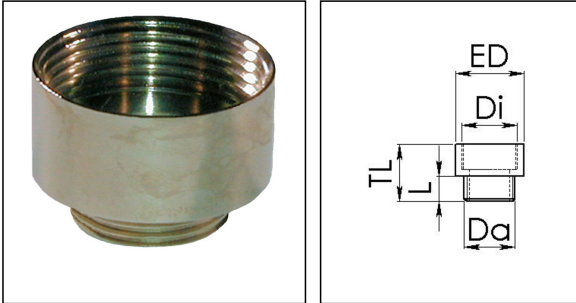

Products may differ in size, colour and appearance to those shown. If you require further information or customisation, please contact us directly.



Material	Brass nickel-plated
Temp. range min	-200 °C
Temp. range max	250 °C
Thread type outer	M
Ø outer thread	25
Lead outer	1,5
Length screw-in thread L	7 mm
Thread type inner	M
Ø inner thread	32
Lead inner	1,5
Length internal thread	9,5 mm
External diameter ED	34 mm
Total length TL	21 mm
Surface	Nickel-plated
Order no. nickel-plated	10063956
Type	MEM 25/32
Packing unit	50
EAN number	4007685639569
Tariff number	74198090
ETIM-Classification	EC000938

Recommended accessories

EMMU 25	10063144
----------------	----------

Your Contact:

WISKA Hoppmann GmbH

Kisdorfer Weg 28 · 24568 Kaltenkirchen · Germany

☎ +49-4191-508-0 · 📠 +49-4191-508-209

contact@wiska.de · www.wiska.com

23.05.2026

Your Contact:

WISKA Hoppmann GmbH

Kisdorfer Weg 28 · 24568 Kaltenkirchen · Germany

 +49-4191-508-0 ·  +49-4191-508-209

contact@wiska.de · www.wiska.com

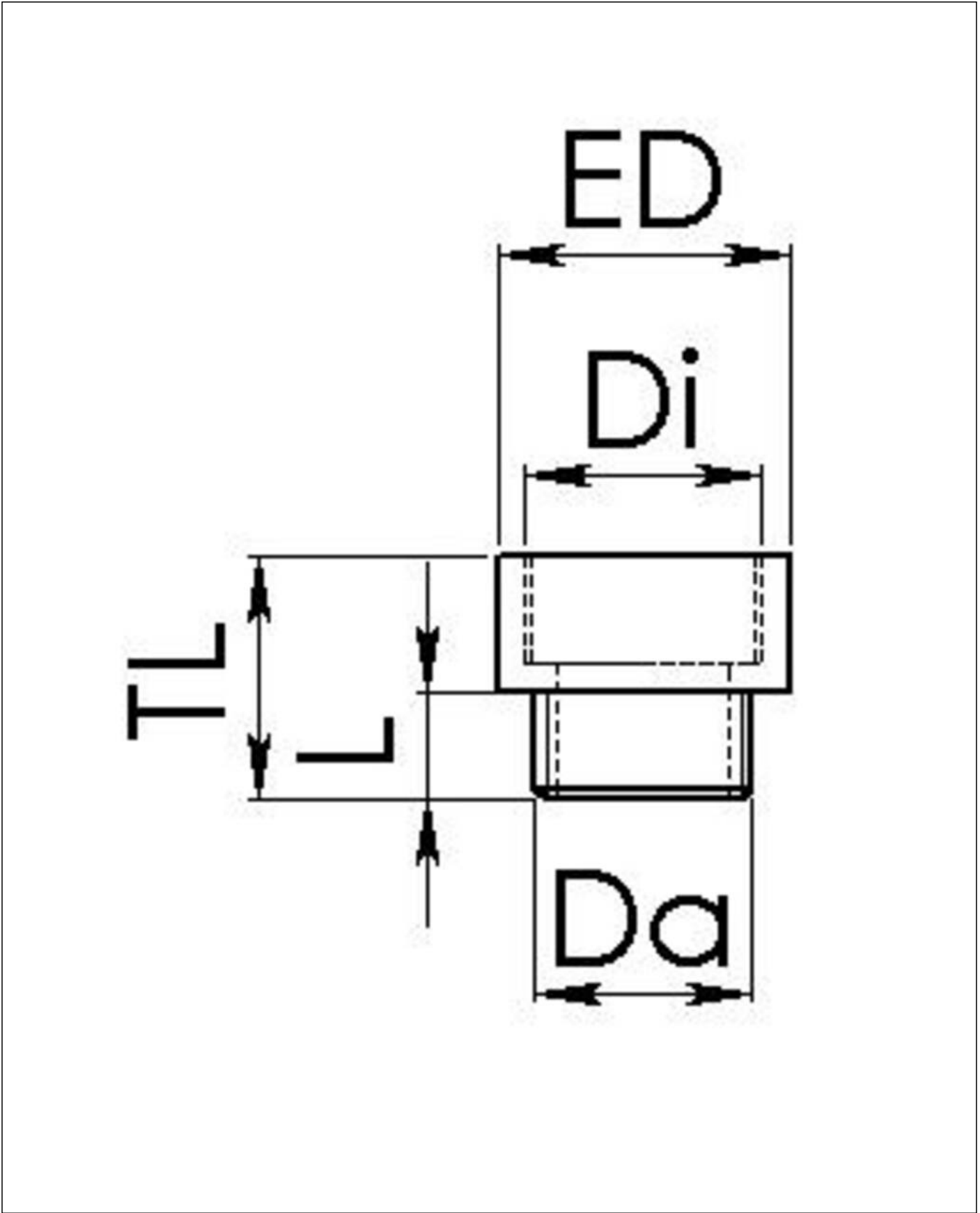

Your Contact:

WISKA Hoppmann GmbH

Kisdorfer Weg 28 · 24568 Kaltenkirchen · Germany

☎ +49-4191-508-0 · 📠 +49-4191-508-209

contact@wiska.de · www.wiska.com