

ESKV-RDE 12 SG

Cable gland with reduction sealing insert, polyamide, M12, RAL 7001

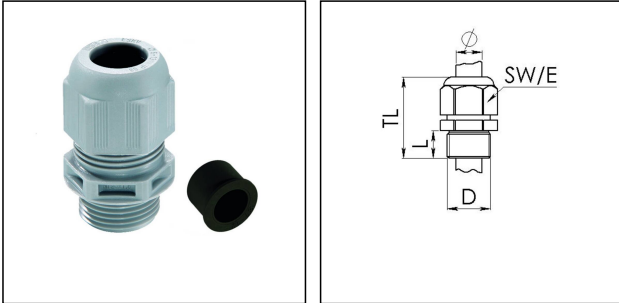

Products may differ in size, colour and appearance to those shown. If you require further information or customisation, please contact us directly.



Material cable gland	Polyamide
Material sealing gasket	EPDM
Protection class	IP69, IP68 (5 bar 30 min)
Temp. range min	-40 °C
Temp. range max	100 °C
Glow wire test	750 °C
Thread type	M
Ø Connection thread D	12
Lead	1,5
Length screw-in thread L	9 mm
Ø cable diameter min	1 mm
Ø cable diameter max	7 mm
Key width SW	16 mm
Collar diameter (E)	18 mm
Total length TL	29 mm - 34 mm
Type of cable anchorage	A
Install. torques fitting	2 N m
Install. torques fitting/EADR	2 N m
Install. torques cap nut	2 N m
Impact category	2
Advice	With reduction insert
Product Color	RAL 7001
Type	ESKV-RDE 12 SG
Order no. RAL 7001	10064984
Packing unit	50

Your Contact:

WISKA Hoppmann GmbH

Kisdorfer Weg 28 · 24568 Kaltenkirchen · Germany

☎ +49-4191-508-0 · 📠 +49-4191-508-209

contact@wiska.de · www.wiska.com

EAN number	4007685649841
Tariff number	39269097
ETIM-Classification	EC000441

Recommended accessories

EMUG 12 SG	10062712
EADR 12	10062801
BS 3	10064001

23.05.2026

Your Contact:

WISKA Hoppmann GmbH

Kisdorfer Weg 28 · 24568 Kaltenkirchen · Germany

☎ +49-4191-508-0 · 📠 +49-4191-508-209

contact@wiska.de · www.wiska.com



Your Contact:

WISKA Hoppmann GmbH

Kisdorfer Weg 28 · 24568 Kaltenkirchen · Germany

☎ +49-4191-508-0 · 📠 +49-4191-508-209

contact@wiska.de · www.wiska.com