

EMSKV 32

Cable gland, brass nickel-plated, M32, with short thread

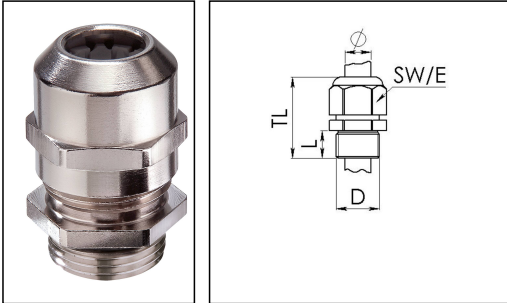

Products may differ in size, colour and appearance to those shown. If you require further information or customisation, please contact us directly.



Material cable gland	Brass nickel-plated
Material clamping cage	Polyamide
Material sealing gasket	EPDM
Temp. range min	-40 °C
Temp. range max	100 °C
Protection class	IP69, IP68 (5 bar 30 min)
Thread type	M
Ø Connection thread D	32
Lead	1,5
Length screw-in thread L	8 mm
Ø cable diameter min	13 mm
Ø cable diameter max	21 mm
Key width SW	36 mm
Collar diameter (E)	40 mm
Total length TL	36 mm - 44 mm
Type of cable anchorage	A
Install. torques fitting	20 N m
Install. torques cap nut	20 N m
Impact category	6
Surface	Nickel-plated
Order no. nickel-plated	10065004
Packing unit	25
Type	EMSKV 32
Tariff number	74198090
EAN number	4007685650045

Your Contact:

WISKA Hoppmann GmbH
Kisdorfer Weg 28 · 24568 Kaltenkirchen · Germany
☎ +49-4191-508-0 · 📠 +49-4191-508-209
contact@wiska.de · www.wiska.com

ETIM-Classification

EC000441

Recommended accessories

RDE 32	10062186
EMMU 32	10063145
BS 21	10064014
MFD 32/04/070	10064344
MFD 32/06/060	10064345
MFD 32/04/080	10064950
MFD 32/03/080	10101018
MFD 32/05/070	10101140
MFD 32/01/115-01/085	10101256
MFD 32/03/065	10102169
MFD 32/03/090	10102170

09.07.2026

Your Contact:

WISKA Hoppmann GmbH

Kisdorfer Weg 28 · 24568 Kaltenkirchen · Germany

☎ +49-4191-508-0 · 📠 +49-4191-508-209

contact@wiska.de · www.wiska.com



Your Contact:

WISKA Hoppmann GmbH

Kisdorfer Weg 28 · 24568 Kaltenkirchen · Germany

☎ +49-4191-508-0 · 📠 +49-4191-508-209

contact@wiska.de · www.wiska.com