

EMSKV 50

Cable gland, brass nickel-plated, M50, with short thread

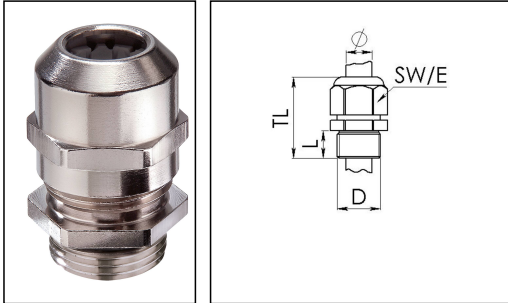

Products may differ in size, colour and appearance to those shown. If you require further information or customisation, please contact us directly.



Material cable gland	Brass nickel-plated
Material clamping cage	Polyamide
Material sealing gasket	EPDM
Temp. range min	-40 °C
Temp. range max	100 °C
Protection class	IP68 (5 bar 30 min), IP69
Thread type	M
Ø Connection thread D	50
Lead	1,5
Length screw-in thread L	9 mm
Ø cable diameter min	21 mm
Ø cable diameter max	35 mm
Key width SW	55 mm
Collar diameter (E)	61 mm
Total length TL	51 mm - 62 mm
Type of cable anchorage	A
Install. torques fitting	30 N m
Install. torques cap nut	30 N m
Impact category	6
Surface	Nickel-plated
Order no. nickel-plated	10065006
Packing unit	10
Type	EMSKV 50
Tariff number	74198090
EAN number	4007685650069

Your Contact:

WISKA Hoppmann GmbH

Kisdorfer Weg 28 · 24568 Kaltenkirchen · Germany

☎ +49-4191-508-0 · 📠 +49-4191-508-209

contact@wiska.de · www.wiska.com

ETIM-Classification

EC000441

Recommended accessories

RDE 50	10062188
MFD 50/25/050	10063102
EMMU 50	10063147
BS 35	10064017
MFD 50/09/080	10064394

09.07.2026

Your Contact:

WISKA Hoppmann GmbH

Kisdorfer Weg 28 · 24568 Kaltenkirchen · Germany

☎ +49-4191-508-0 · 📠 +49-4191-508-209

contact@wiska.de · www.wiska.com



Your Contact:

WISKA Hoppmann GmbH

Kisdorfer Weg 28 · 24568 Kaltenkirchen · Germany

☎ +49-4191-508-0 · 📠 +49-4191-508-209

contact@wiska.de · www.wiska.com