

EMSKV-L 40

Cable gland, brass nickel-plated, M40, with long thread

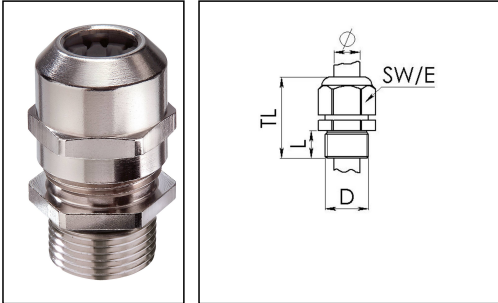

Products may differ in size, colour and appearance to those shown. If you require further information or customisation, please contact us directly.



Material cable gland	Brass nickel-plated
Material clamping cage	Polyamide
Material sealing gasket	EPDM
Temp. range min	-40 °C
Temp. range max	100 °C
Protection class	IP68 (5 bar 30 min), IP69
Thread type	M
Ø Connection thread D	40
Lead	1,5
Length screw-in thread L	15 mm
Ø cable diameter min	16 mm
Ø cable diameter max	28 mm
Key width SW	46 mm
Collar diameter (E)	50 mm
Total length TL	51 mm - 62 mm
Type of cable anchorage	A
Install. torques fitting	20 N m
Install. torques cap nut	20 N m
Impact category	6
Surface	Nickel-plated
Order no. nickel-plated	10065013
Packing unit	10
Type	EMSKV-L 40
Tariff number	74198090
EAN number	4007685650137

Your Contact:

WISKA Hoppmann GmbH

Kisdorfer Weg 28 · 24568 Kaltenkirchen · Germany

☎ +49-4191-508-0 · 📠 +49-4191-508-209

contact@wiska.de · www.wiska.com

ETIM-Classification

EC000441

Recommended accessories

RDE 40	10062187
EMMU 40	10063146
BS 28	10064016
MFD 40/08/060	10064346
MFD 40/07/080	10064347
MFD 40/07/070	10064348
MFD 40/04/100	10101017
MFD 40/09/069	10101427
MFD 40/03/125	10102054
MFD 40/06/065	10102171
MFD 40/06/090	10102172

26.06.2026

Your Contact:

WISKA Hoppmann GmbH

Kisdorfer Weg 28 · 24568 Kaltenkirchen · Germany

☎ +49-4191-508-0 · 📠 +49-4191-508-209

contact@wiska.de · www.wiska.com



Your Contact:

WISKA Hoppmann GmbH

Kisdorfer Weg 28 · 24568 Kaltenkirchen · Germany

☎ +49-4191-508-0 · 📠 +49-4191-508-209

contact@wiska.de · www.wiska.com