

EMSKE-L 16

Ex-cable gland, brass nickel-plated with long thread, M16

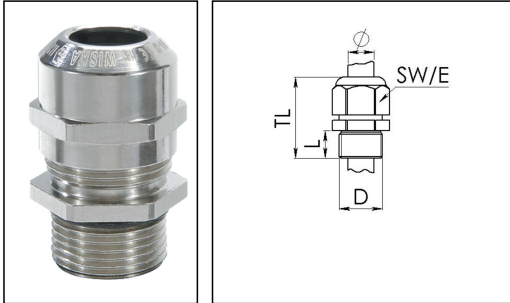

Products may differ in size, colour and appearance to those shown. If you require further information or customisation, please contact us directly.



Material cable gland	Brass nickel-plated
Material clamping cage	Polyamide
Material sealing gasket	EPDM
Temp. range min	-40 °C
Temp. range max	75 °C
Protection class	IP66 / IP68 (5 bar 30 min)
Type of protection	Ex eb, Ex tb
Ex-Certificate	ATEX, IECEx
Thread type	M
Ø Connection thread D	16
Lead	1,5
Length screw-in thread L	12 mm
Ø cable diameter min	5 mm
Ø cable diameter max	10 mm
Key width SW	20 mm
Collar diameter (E)	22 mm
Total length TL	33 mm - 41 mm
Install. torques fitting	4 N m
Install. torques cap nut	4 N m
Surface	Nickel-plated
Order no. nickel-plated	10065049
Type	EMSKE-L 16
Packing unit	50
Tariff number	74198090
EAN number	4007685650496

Your Contact:

WISKA Hoppmann GmbH
Kisdorfer Weg 28 · 24568 Kaltenkirchen · Germany
☎ +49-4191-508-0 · 📠 +49-4191-508-209
contact@wiska.de · www.wiska.com

ETIM-Classification

EC000441

Recommended accessories

RDE 16	10062184
EMMU 16	10063142
BS 10	10064008

23.05.2026

Your Contact:

WISKA Hoppmann GmbH

Kisdorfer Weg 28 · 24568 Kaltenkirchen · Germany

☎ +49-4191-508-0 · 📠 +49-4191-508-209

contact@wiska.de · www.wiska.com



Your Contact:

WISKA Hoppmann GmbH

Kisdorfer Weg 28 · 24568 Kaltenkirchen · Germany

☎ +49-4191-508-0 · 📠 +49-4191-508-209

contact@wiska.de · www.wiska.com