

EMSKE-L 63

Ex-cable gland, brass nickel-plated with long thread, M63

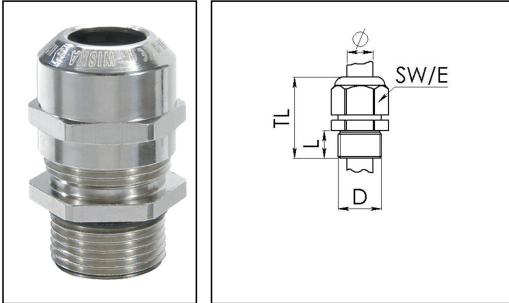

Products may differ in size, colour and appearance to those shown. If you require further information or customisation, please contact us directly.



Material cable gland	Brass nickel-plated
Material clamping cage	Polyamide
Material sealing gasket	EPDM
Temp. range min	-40 °C
Temp. range max	75 °C
Protection class	IP66 / IP68 (5 bar 30 min)
Type of protection	Ex eb, Ex tb
Ex-Certificate	ATEX, IECEx
Thread type	M
Ø Connection thread D	63
Lead	1,5
Length screw-in thread L	15 mm
Ø cable diameter min	34 mm
Ø cable diameter max	48 mm
Key width SW	68 mm
Collar diameter (E)	75 mm
Total length TL	61 mm - 72 mm
Install. torques fitting	40 N m
Install. torques cap nut	40 N m
Surface	Nickel-plated
Order no. nickel-plated	10065055
Type	EMSKE-L 63
Packing unit	10
Tariff number	74198090
EAN number	4007685650557

Your Contact:

WISKA Hoppmann GmbH

Kisdorfer Weg 28 · 24568 Kaltenkirchen · Germany

☎ +49-4191-508-0 · 📠 +49-4191-508-209

contact@wiska.de · www.wiska.com

ETIM-Classification

EC000441

Recommended accessories

RDE 63	10062189
EMMU 63	10063148
BS 48	10064019

23.05.2026

Your Contact:

WISKA Hoppmann GmbH

Kisdorfer Weg 28 · 24568 Kaltenkirchen · Germany

☎ +49-4191-508-0 · 📠 +49-4191-508-209

contact@wiska.de · www.wiska.com



Your Contact:

WISKA Hoppmann GmbH

Kisdorfer Weg 28 · 24568 Kaltenkirchen · Germany

☎ +49-4191-508-0 · 📠 +49-4191-508-209

contact@wiska.de · www.wiska.com