

EMSKV-L 20 LT

Cable gland LowTemp, brass nickel-plated, M20, with long thread

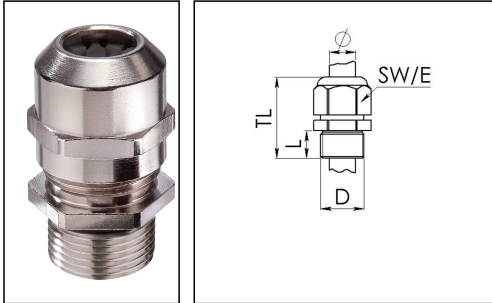

Products may differ in size, colour and appearance to those shown. If you require further information or customisation, please contact us directly.



Material cable gland	Brass nickel-plated
Material clamping cage	Polyamide
Material sealing gasket	Silicone
Temp. range min	-60 °C
Temp. range max	100 °C
Protection class	IP69, IP68 (5 bar 30 min)
Thread type	M
Ø Connection thread D	20
Lead	1,5
Length screw-in thread L	12 mm
Ø cable diameter min	6 mm
Ø cable diameter max	13 mm
Key width SW	24 mm
Collar diameter (E)	27 mm
Total length TL	35 mm - 43 mm
Type of cable anchorage	A
Install. torques fitting	8 N m
Install. torques cap nut	8 N m
Impact category	27
Surface	Nickel-plated
Order no. nickel-plated	10065810
Packing unit	50
Type	EMSKV-L 20 LT
Tariff number	74198090
EAN number	4007685658102

Your Contact:

WISKA Hoppmann GmbH

Kisdorfer Weg 28 · 24568 Kaltenkirchen · Germany

☎ +49-4191-508-0 · 📠 +49-4191-508-209

contact@wiska.de · www.wiska.com

ETIM-Classification

EC000441

Recommended accessories

EMMU 20	10063143
RDE 20 LT	10063909
BS 13	10064010

23.05.2026

Your Contact:

WISKA Hoppmann GmbH

Kisdorfer Weg 28 · 24568 Kaltenkirchen · Germany

☎ +49-4191-508-0 · 📠 +49-4191-508-209

contact@wiska.de · www.wiska.com



Your Contact:

WISKA Hoppmann GmbH

Kisdorfer Weg 28 · 24568 Kaltenkirchen · Germany

☎ +49-4191-508-0 · 📠 +49-4191-508-209

contact@wiska.de · www.wiska.com