

EMSKV-L 40 LT

Cable gland LowTemp, brass nickel-plated, M40, with long thread

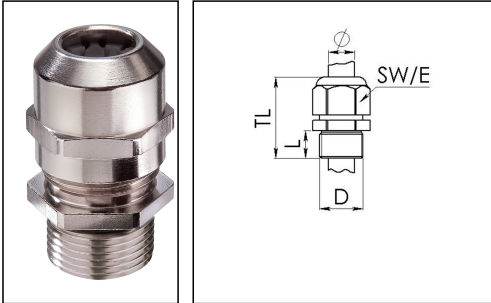

Products may differ in size, colour and appearance to those shown. If you require further information or customisation, please contact us directly.



Material cable gland	Brass nickel-plated
Material clamping cage	Polyamide
Material sealing gasket	Silicone
Temp. range min	-60 °C
Temp. range max	100 °C
Protection class	IP69, IP68 (5 bar 30 min)
Thread type	M
Ø Connection thread D	40
Lead	1,5
Length screw-in thread L	15 mm
Ø cable diameter min	16 mm
Ø cable diameter max	28 mm
Key width SW	46 mm
Collar diameter (E)	50 mm
Total length TL	51 mm - 62 mm
Type of cable anchorage	A
Install. torques fitting	20 N m
Install. torques cap nut	20 N m
Impact category	6
Surface	Nickel-plated
Order no. nickel-plated	10065813
Packing unit	10
Type	EMSKV-L 40 LT
Tariff number	74198090
EAN number	4007685658133

Your Contact:

WISKA Hoppmann GmbH

Kisdorfer Weg 28 · 24568 Kaltenkirchen · Germany

☎ +49-4191-508-0 · 📠 +49-4191-508-209

contact@wiska.de · www.wiska.com

ETIM-Classification

EC000441

Recommended accessories

EMMU 40	10063146
RDE 40 LT	10063960
BS 28	10064016

23.05.2026

Your Contact:

WISKA Hoppmann GmbH

Kisdorfer Weg 28 · 24568 Kaltenkirchen · Germany

☎ +49-4191-508-0 · 📠 +49-4191-508-209

contact@wiska.de · www.wiska.com



Your Contact:

WISKA Hoppmann GmbH

Kisdorfer Weg 28 · 24568 Kaltenkirchen · Germany

☎ +49-4191-508-0 · 📠 +49-4191-508-209

contact@wiska.de · www.wiska.com