

EMSKVZ-L 32

Cable gland long, brass nickel-plated, M32, with external strain relief

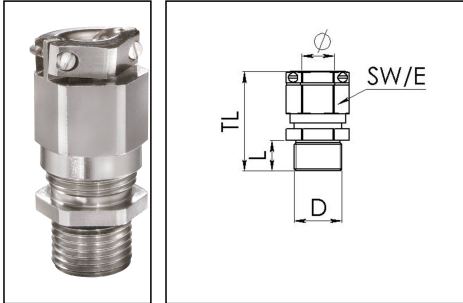

Products may differ in size, colour and appearance to those shown. If you require further information or customisation, please contact us directly.



Material cable gland	Brass nickel-plated
Material clamping cage	Polyamide
Material sealing gasket	EPDM
Temp. range min	-40 °C
Temp. range max	100 °C
Protection class	IP69, IP68 (5 bar 30 min)
Thread type	M
Ø Connection thread D	32
Lead	1,5
Length screw-in thread L	15 mm
Ø cable diameter min	13 mm
Ø cable diameter max	21 mm
Key width SW	36 mm
Collar diameter (E)	40 mm
Total length TL	53 mm - 61 mm
Type of cable anchorage	B
Install. torques fitting	20 N m
Install. torques cap nut	20 N m
Impact category	6
Torque clamp srew	0,5 N m
Surface	Nickel-plated
Order no. nickel-plated	10065863
Packing unit	10
Type	EMSKVZ-L 32
Tariff number	74198090

Your Contact:

WISKA Hoppmann GmbH

Kisdorfer Weg 28 · 24568 Kaltenkirchen · Germany

☎ +49-4191-508-0 · 📠 +49-4191-508-209

contact@wiska.de · www.wiska.com

EAN number	4007685658638
ETIM-Classification	EC000441

Recommended accessories

RDE 32	10062186
EMMU 32	10063145
BS 21	10064014

23.05.2026

Your Contact:

WISKA Hoppmann GmbH

Kisdorfer Weg 28 · 24568 Kaltenkirchen · Germany

☎ +49-4191-508-0 · 📠 +49-4191-508-209

contact@wiska.de · www.wiska.com

