

## EMSKVZ-L 50

Cable gland long, brass nickel-plated, M50, with external strain relief

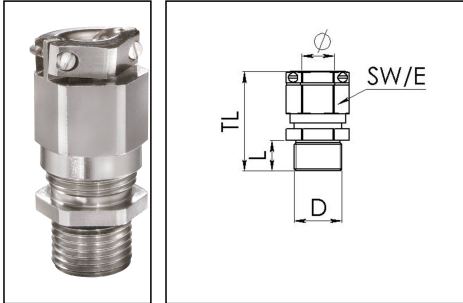

Products may differ in size, colour and appearance to those shown. If you require further information or customisation, please contact us directly.



<b>Material cable gland</b>	Brass nickel-plated
<b>Material clamping cage</b>	Polyamide
<b>Material sealing gasket</b>	EPDM
<b>Temp. range min</b>	-40 °C
<b>Temp. range max</b>	100 °C
<b>Protection class</b>	IP69, IP68 (5 bar 30 min)
<b>Thread type</b>	M
<b>Ø Connection thread D</b>	50
<b>Lead</b>	1,5
<b>Length screw-in thread L</b>	15 mm
<b>Ø cable diameter min</b>	21 mm
<b>Ø cable diameter max</b>	35 mm
<b>Key width SW</b>	55 mm
<b>Collar diameter (E)</b>	61 mm
<b>Total length TL</b>	69 mm - 80 mm
<b>Type of cable anchorage</b>	B
<b>Install. torques fitting</b>	30 N m
<b>Install. torques cap nut</b>	30 N m
<b>Impact category</b>	6
<b>Torque clamp srew</b>	0,6 N m
<b>Surface</b>	Nickel-plated
<b>Order no. nickel-plated</b>	10065865
<b>Packing unit</b>	5
<b>Type</b>	EMSKVZ-L 50
<b>Tariff number</b>	74198090

Your Contact:

WISKA Hoppmann GmbH

Kisdorfer Weg 28 · 24568 Kaltenkirchen · Germany

☎ +49-4191-508-0 · 📠 +49-4191-508-209

contact@wiska.de · www.wiska.com

<b>EAN number</b>	4007685658652
<b>ETIM-Classification</b>	EC000441

## Recommended accessories

<b>RDE 50</b>	10062188
<b>EMMU 50</b>	10063147
<b>BS 35</b>	10064017

23.05.2026

Your Contact:

**WISKA Hoppmann GmbH**

Kisdorfer Weg 28 · 24568 Kaltenkirchen · Germany

☎ +49-4191-508-0 · 📠 +49-4191-508-209

contact@wiska.de · www.wiska.com

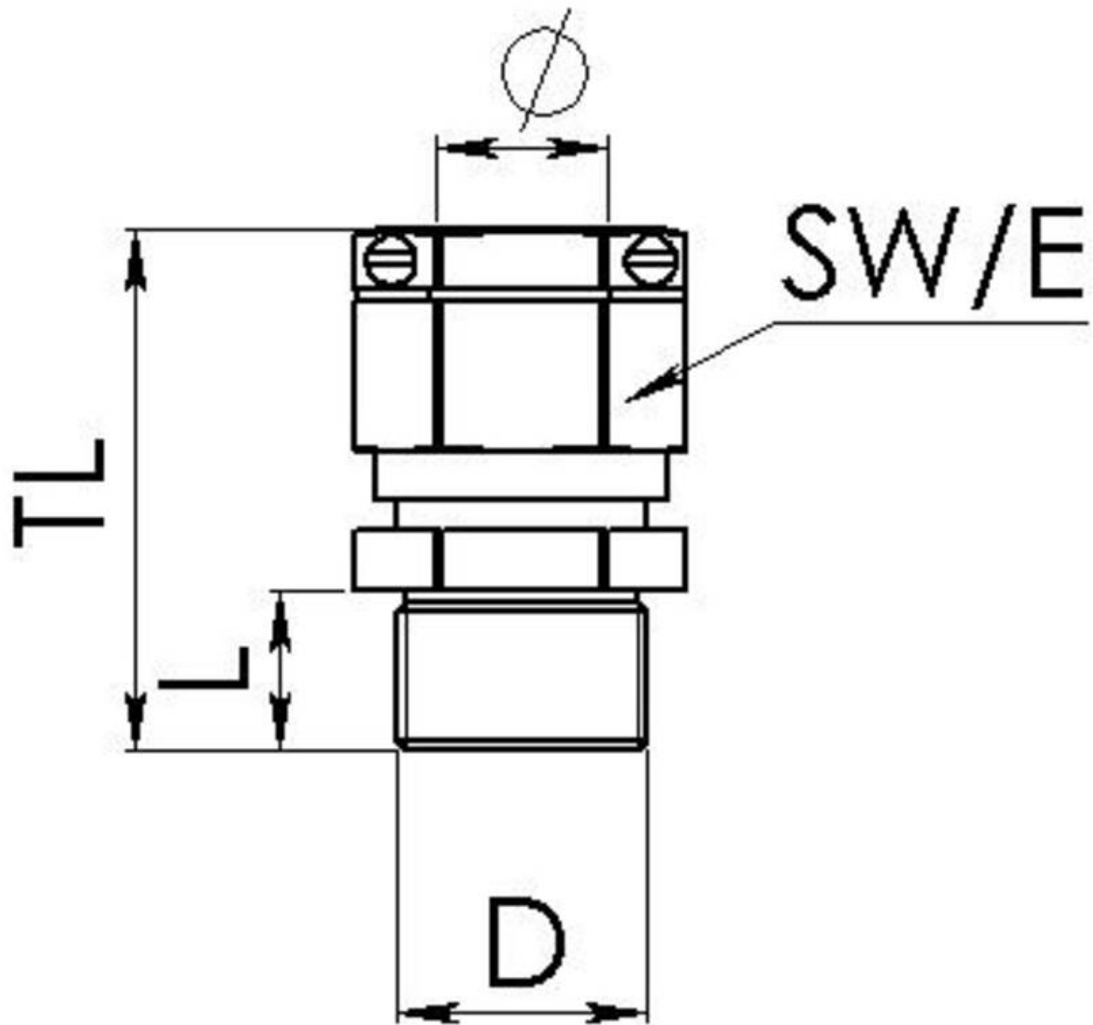

Your Contact:

**WISKA Hoppmann GmbH**

Kisdorfer Weg 28 · 24568 Kaltenkirchen · Germany

☎ +49-4191-508-0 · 📠 +49-4191-508-209

contact@wiska.de · www.wiska.com