

EMSKE-L 20 EMV-Z

Ex-EMC cable gland, earthing cones DIN 89345, brass nickel-plated, M20

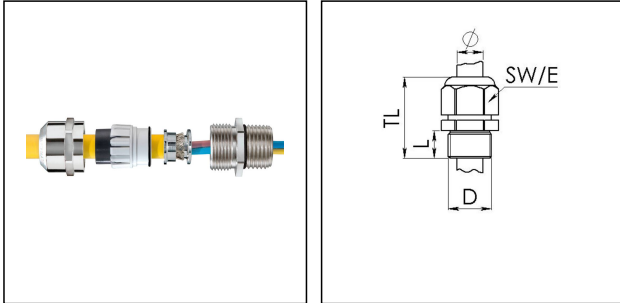

Products may differ in size, colour and appearance to those shown. If you require further information or customisation, please contact us directly.



Material cable gland	Brass nickel-plated
Material clamping cage	Polyamide
Material sealing gasket	EPDM
Material earthing insert	Brass plated
Temp. range min	-40 °C
Temp. range max	75 °C
Protection class	IP66 / IP68 (5 bar 30 min)
Type of protection	Ex eb, Ex tb
Ex-Certificate	ATEX, IECEx
Thread type	M
Ø Connection thread D	20
Lead	1,5
Length screw-in thread L	12 mm
Ø cable diameter min	6 mm
Ø cable diameter max	13 mm
Ø cable below cable shield max	9,5 mm
Key width SW	24 mm
Collar diameter (E)	27 mm
Total length TL	35 mm - 43 mm
Install. torques fitting	8 N m
Install. torques cap nut	8 N m
Surface	Nickel-plated
Order no. nickel-plated	10065924
Type	EMSKE-L 20 EMV-Z
Packing unit	50

Your Contact:

WISKA Hoppmann GmbH
Kisdorfer Weg 28 · 24568 Kaltenkirchen · Germany
☎ +49-4191-508-0 · 📠 +49-4191-508-209
contact@wiska.de · www.wiska.com

Tariff number	85369010
EAN number	4007685659246
ETIM-Classification	EC000441

Recommended accessories

RDE 20	10062185
EMMU-EMV 20	10063212
BS 13	10064010

12.05.2026

Your Contact:

WISKA Hoppmann GmbH

Kisdorfer Weg 28 · 24568 Kaltenkirchen · Germany

☎ +49-4191-508-0 · 📠 +49-4191-508-209

contact@wiska.de · www.wiska.com



Your Contact:

WISKA Hoppmann GmbH

Kisdorfer Weg 28 · 24568 Kaltenkirchen · Germany

☎ +49-4191-508-0 · 📠 +49-4191-508-209

contact@wiska.de · www.wiska.com