

EMSKE-L 50 EMV-Z

Ex-EMC cable gland, earthing cones DIN 89345, brass nickel-plated, M50

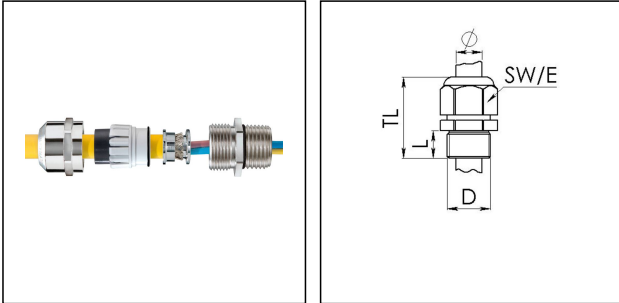

Products may differ in size, colour and appearance to those shown. If you require further information or customisation, please contact us directly.



Material cable gland	Brass nickel-plated
Material clamping cage	Polyamide
Material sealing gasket	EPDM
Material earthing insert	Brass plated
Temp. range min	-40 °C
Temp. range max	75 °C
Protection class	IP66 / IP68 (5 bar 30 min)
Type of protection	Ex eb, Ex tb
Ex-Certificate	ATEX, IECEx
Thread type	M
Ø Connection thread D	50
Lead	1,5
Length screw-in thread L	15 mm
Ø cable diameter min	21 mm
Ø cable diameter max	35 mm
Ø cable below cable shield max	33 mm
Key width SW	55 mm
Collar diameter (E)	61 mm
Total length TL	57 mm - 68 mm
Install. torques fitting	30 N m
Install. torques cap nut	30 N m
Surface	Nickel-plated
Order no. nickel-plated	10065928
Type	EMSKE-L 50 EMV-Z
Packing unit	10

Your Contact:

WISKA Hoppmann GmbH
Kisdorfer Weg 28 · 24568 Kaltenkirchen · Germany
☎ +49-4191-508-0 · 📠 +49-4191-508-209
contact@wiska.de · www.wiska.com

Tariff number	85369010
EAN number	4007685659284
ETIM-Classification	EC000441

Recommended accessories

RDE 50	10062188
EMMU-EMV 50	10063216
BS 35	10064017

12.05.2026

Your Contact:

WISKA Hoppmann GmbH

Kisdorfer Weg 28 · 24568 Kaltenkirchen · Germany

☎ +49-4191-508-0 · 📠 +49-4191-508-209

contact@wiska.de · www.wiska.com



Your Contact:

WISKA Hoppmann GmbH

Kisdorfer Weg 28 · 24568 Kaltenkirchen · Germany

☎ +49-4191-508-0 · 📠 +49-4191-508-209

contact@wiska.de · www.wiska.com