

SKV 36 SG

Cable gland, polyamide, Pg 36 RAL 7001

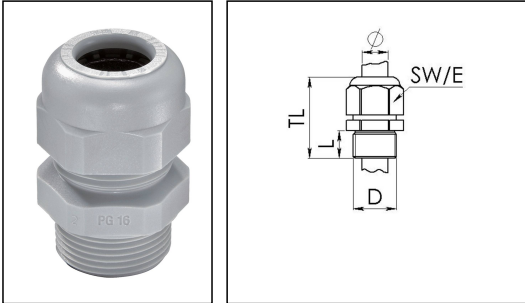

Products may differ in size, colour and appearance to those shown. If you require further information or customisation, please contact us directly.



Material cable gland	Polyamide
Material sealing gasket	EPDM
Protection class	IP68 (5 bar 30 min)
Temp. range min	-40 °C
Temp. range max	100 °C
Glow wire test	750 °C
Thread type	PG
Ø Connection thread D	36
Length screw-in thread L	14 mm
Ø cable diameter min	22 mm
Ø cable diameter max	32 mm
Key width SW	53 mm
Collar diameter (E)	59 mm
Total length TL	56 mm - 65 mm
Type of cable anchorage	A
Product Color	RAL 7001
Type	SKV 36 SG
Order no. RAL 7001	10066008
Packing unit	10
EAN number	4007685660082
Tariff number	39269097
ETIM-Classification	EC000441

Your Contact:

WISKA Hoppmann GmbH

Kisdorfer Weg 28 · 24568 Kaltenkirchen · Germany

☎ +49-4191-508-0 · 📠 +49-4191-508-209

contact@wiska.de · www.wiska.com

Recommended accessories

ADR 36	10061426
BS 28	10064016

23.05.2026

Your Contact:

WISKA Hoppmann GmbH

Kisdorfer Weg 28 · 24568 Kaltenkirchen · Germany

☎ +49-4191-508-0 · 📠 +49-4191-508-209

contact@wiska.de · www.wiska.com



Your Contact:

WISKA Hoppmann GmbH

Kisdorfer Weg 28 · 24568 Kaltenkirchen · Germany

☎ +49-4191-508-0 · 📠 +49-4191-508-209

contact@wiska.de · www.wiska.com