

SKV 9 BK

Cable gland, polyamide, Pg 9, RAL 9005

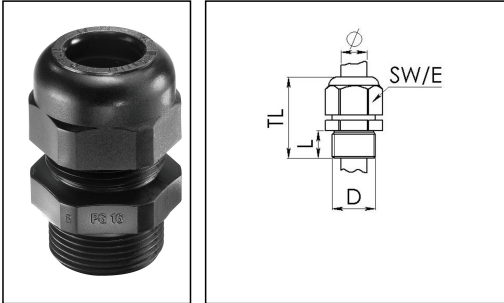

Products may differ in size, colour and appearance to those shown. If you require further information or customisation, please contact us directly.



Material cable gland	Polyamide
Material sealing gasket	EPDM
Protection class	IP68 (5 bar 30 min)
Temp. range min	-40 °C
Temp. range max	100 °C
Glow wire test	750 °C
Thread type	PG
Ø Connection thread D	9
Length screw-in thread L	9 mm
Ø cable diameter min	4 mm
Ø cable diameter max	8 mm
Key width SW	19 mm
Collar diameter (E)	21 mm
Total length TL	32 mm - 36 mm
Type of cable anchorage	A
Install. torques fitting	3,8 N m
Install. torques cap nut	2,5 N m
Product Color	RAL 9005
Type	SKV 9 BK
Order no. RAL 9005	10066192
Packing unit	50
EAN number	4007685661928
Tariff number	39269097
ETIM-Classification	EC000441

Your Contact:

WISKA Hoppmann GmbH

Kisdorfer Weg 28 · 24568 Kaltenkirchen · Germany

☎ +49-4191-508-0 · 📠 +49-4191-508-209

contact@wiska.de · www.wiska.com

Recommended accessories

MUG 9 BK	10060681
ADR 9	10061420
BS 8	10064006

07.07.2026

Your Contact:

WISKA Hoppmann GmbH

Kisdorfer Weg 28 · 24568 Kaltenkirchen · Germany

☎ +49-4191-508-0 · 📠 +49-4191-508-209

contact@wiska.de · www.wiska.com



Your Contact:

WISKA Hoppmann GmbH

Kisdorfer Weg 28 · 24568 Kaltenkirchen · Germany

☎ +49-4191-508-0 · 📠 +49-4191-508-209

contact@wiska.de · www.wiska.com