

ESSKE 12

Ex-cable gland, stainless steel 1.4305, M12

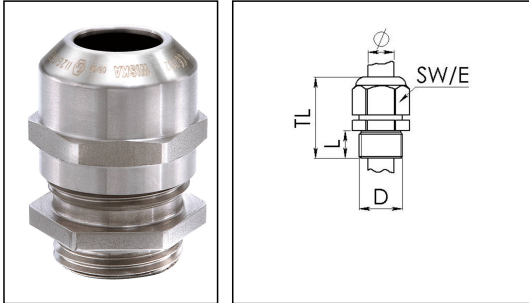

Products may differ in size, colour and appearance to those shown. If you require further information or customisation, please contact us directly.



Material cable gland	Stainless steel A2 (1.4305)
Material clamping cage	Polyamide
Material sealing gasket	EPDM
Temp. range min	-40 °C
Temp. range max	75 °C
Protection class	IP66 / IP68 (5 bar 30 min)
Type of protection	Ex tb, Ex eb
Ex-Certificate	ATEX, IECEx
Thread type	M
Ø Connection thread D	12
Lead	1,5
Length screw-in thread L	5 mm
Ø cable diameter min	4 mm
Ø cable diameter max	7 mm
Key width SW	17 mm
Collar diameter (E)	19 mm
Total length TL	23 mm - 30 mm
Install. torques fitting	4 N m
Install. torques cap nut	4 N m
WISKA-Order no.	10069200
Type	ESSKE 12
Packing unit	10
Tariff number	73269098
EAN number	4007685692007
ETIM-Classification	EC000441

Your Contact:

WISKA Hoppmann GmbH

Kisdorfer Weg 28 · 24568 Kaltenkirchen · Germany

☎ +49-4191-508-0 · 📠 +49-4191-508-209

contact@wiska.de · www.wiska.com

Recommended accessories

RDE 12	10062183
BS 7	10064005
ESMU 12	10064188

12.05.2026

Your Contact:

WISKA Hoppmann GmbH

Kisdorfer Weg 28 · 24568 Kaltenkirchen · Germany

 +49-4191-508-0 ·  +49-4191-508-209

contact@wiska.de · www.wiska.com



Your Contact:

WISKA Hoppmann GmbH

Kisdorfer Weg 28 · 24568 Kaltenkirchen · Germany

☎ +49-4191-508-0 · 📠 +49-4191-508-209

contact@wiska.de · www.wiska.com