

ESSKE-4 16

Ex-cable gland, stainless steel 1.4404, M16

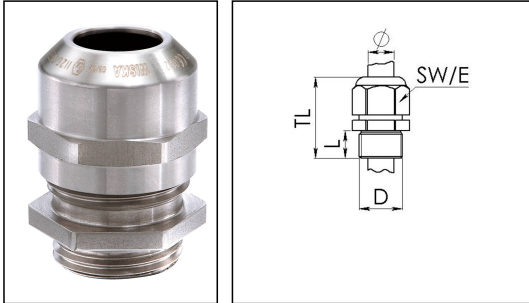

Products may differ in size, colour and appearance to those shown. If you require further information or customisation, please contact us directly.



Material cable gland	Stainless steel A4 (1.4404)
Material clamping cage	Polyamide
Material sealing gasket	EPDM
Temp. range min	-40 °C
Temp. range max	75 °C
Protection class	IP66 / IP68 (5 bar 30 min)
Type of protection	Ex eb, Ex tb
Ex-Certificate	IECEX, ATEX
Thread type	M
Ø Connection thread D	16
Lead	1,5
Length screw-in thread L	5 mm
Ø cable diameter min	5 mm
Ø cable diameter max	10 mm
Key width SW	22 mm
Collar diameter (E)	24 mm
Total length TL	26 mm - 34 mm
Install. torques fitting	4 N m
Install. torques cap nut	4 N m
WISKA-Order no.	10069233
Type	ESSKE-4 16
Packing unit	10
Tariff number	73269098
EAN number	4007685692335
ETIM-Classification	EC000441

Your Contact:

WISKA Hoppmann GmbH

Kisdorfer Weg 28 · 24568 Kaltenkirchen · Germany

☎ +49-4191-508-0 · 📠 +49-4191-508-209

contact@wiska.de · www.wiska.com

Recommended accessories

RDE 16	10062184
BS 10	10064008

23.05.2026

Your Contact:

WISKA Hoppmann GmbH

Kisdorfer Weg 28 · 24568 Kaltenkirchen · Germany

☎ +49-4191-508-0 · 📠 +49-4191-508-209

contact@wiska.de · www.wiska.com



Your Contact:

WISKA Hoppmann GmbH

Kisdorfer Weg 28 · 24568 Kaltenkirchen · Germany

☎ +49-4191-508-0 · 📠 +49-4191-508-209

contact@wiska.de · www.wiska.com