

IBS 302008

IBS Industry boxes system 340x206x100mm, stainless steel

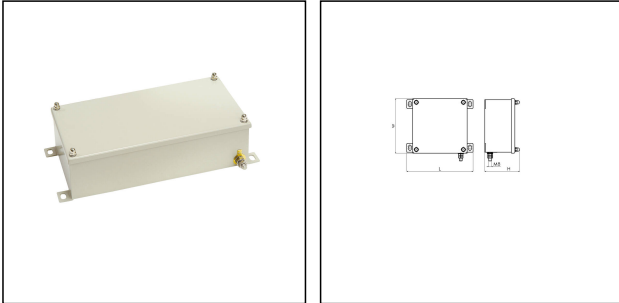

Products may differ in size, colour and appearance to those shown. If you require further information or customisation, please contact us directly.

WISKA-Order no.	10074205
Type	IBS 302008
Protection class	IP66 / IP67
Material	Stainless steel 1.4301 (V2A)
Mounting hole space	322x175mm
External dimensions LxWxH	340x206x100 mm
Internal dimensions LxWxH	280x180x77 mm
Mounting	Surface mounting
Temp. range min	-40 °C
Temp. range max	120 °C
Equipment	none
Terminals/poles	None
Operational areas	Indoor work space, Engine room, Outdoor
Colour	RAL 7032
Weight	2,73 kg
Equipment	Empty and undrilled
Variations	on request
Tariff number	85369010

Remarks:

- Earthing bolts inside and outside
- Indestructible allround cover seal
- Protection specification acc. to EN 50102 (external mechanical impacts): IK 08

Spare parts

Your Contact:

WISKA Hoppmann GmbH

Kisdorfer Weg 28 · 24568 Kaltenkirchen · Germany

☎ +49-4191-508-0 · 📠 +49-4191-508-209

contact@wiska.de · www.wiska.com

12.05.2026

Your Contact:

WISKA Hoppmann GmbH

Kisdorfer Weg 28 · 24568 Kaltenkirchen · Germany

☎ +49-4191-508-0 · 📠 +49-4191-508-209

contact@wiska.de · www.wiska.com

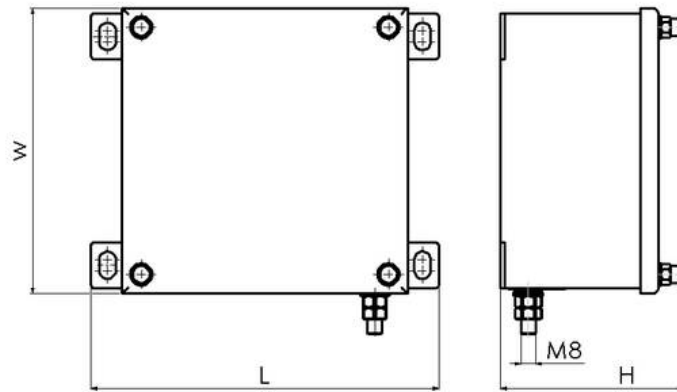

Your Contact:

WISKA Hoppmann GmbH

Kisdorfer Weg 28 · 24568 Kaltenkirchen · Germany

☎ +49-4191-508-0 · 📠 +49-4191-508-209

contact@wiska.de · www.wiska.com