

PMSKV 7-16

Cable gland, brass nickel-plated, Pg 7

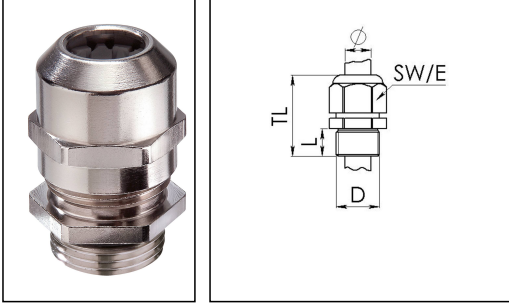

Products may differ in size, colour and appearance to those shown. If you require further information or customisation, please contact us directly.



Material cable gland	Brass nickel-plated
Material clamping cage	Polyamide
Material sealing gasket	EPDM
Temp. range min	-40 °C
Temp. range max	100 °C
Protection class	IP69, IP68 (5 bar 30 min)
Thread type	PG
Ø Connection thread D	7
Length screw-in thread L	5 mm
Ø cable diameter min	4,5 mm
Ø cable diameter max	10 mm
Key width SW	20 mm
Collar diameter (E)	22 mm
Total length TL	26 mm - 34 mm
Type of cable anchorage	A
Install. torques fitting	4 N m
Install. torques cap nut	4 N m
Impact category	6
Surface	Nickel-plated
Order no. nickel-plated	10100678
Packing unit	50
Type	PMSKV 7-16
Tariff number	74198090
EAN number	4007685059466
ETIM-Classification	EC000441

Your Contact:

WISKA Hoppmann GmbH

Kisdorfer Weg 28 · 24568 Kaltenkirchen · Germany

☎ +49-4191-508-0 · 📠 +49-4191-508-209

contact@wiska.de · www.wiska.com

Recommended accessories

MMU 7	10062141
BS 10	10064008
MFD 16/02/040	10064393
MFD 16/03/021	10101014

12.05.2026

Your Contact:

WISKA Hoppmann GmbH

Kisdorfer Weg 28 · 24568 Kaltenkirchen · Germany

 +49-4191-508-0 ·  +49-4191-508-209

contact@wiska.de · www.wiska.com



Your Contact:

WISKA Hoppmann GmbH

Kisdorfer Weg 28 · 24568 Kaltenkirchen · Germany

☎ +49-4191-508-0 · 📠 +49-4191-508-209

contact@wiska.de · www.wiska.com