

## ESVG 32 LG

Pressure compensation cable gland, polyamide, RAL 7035, M32

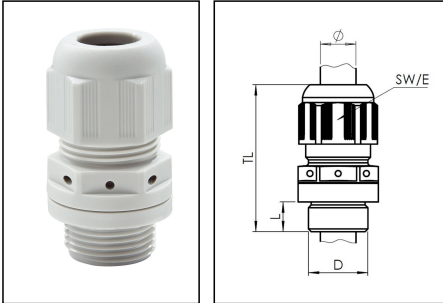

Products may differ in size, colour and appearance to those shown. If you require further information or customisation, please contact us directly.



<b>Material cable gland</b>	Polyamide
<b>Material membrane</b>	ePTFE
<b>Material sealing gasket</b>	EPDM
<b>Airflow at 70mbar</b>	115 l/h
<b>Temp. range min</b>	-40 °C
<b>Temp. range max</b>	100 °C
<b>Glow wire test</b>	750 °C
<b>Protection class</b>	IP68 / IP69
<b>Thread type</b>	M
<b>Ø Connection thread D</b>	32
<b>Lead</b>	1,5
<b>Length screw-in thread L</b>	12 mm
<b>Ø cable diameter min</b>	13 mm
<b>Ø cable diameter max</b>	21 mm
<b>Key width SW</b>	36 mm
<b>Collar diameter (E)</b>	40 mm
<b>Install. torques fitting</b>	4 N m
<b>Install. torques cap nut</b>	3 N m
<b>Total length TL</b>	49 mm - 58 mm
<b>Equipment</b>	Incl. connection thread gasket
<b>Product Color</b>	RAL 7035
<b>Order no. RAL 7035</b>	10100801
<b>Type</b>	ESVG 32 LG
<b>Packing unit</b>	1
<b>EAN number</b>	4007685058148

Your Contact:

WISKA Hoppmann GmbH

Kisdorfer Weg 28 · 24568 Kaltenkirchen · Germany

☎ +49-4191-508-0 · 📠 +49-4191-508-209

contact@wiska.de · www.wiska.com

<b>Tariff number</b>	39269097
<b>ETIM-Classification</b>	EC000441

## Recommended accessories

<b>EMUG 32 LG</b>	10060774
<b>RDE 32</b>	10062186
<b>BS 21</b>	10064014
<b>MFD 32/04/070</b>	10064344
<b>MFD 32/06/060</b>	10064345
<b>MFD 32/04/080</b>	10064950
<b>MFD 32/03/080</b>	10101018
<b>MFD 32/05/070</b>	10101140
<b>MFD 32/01/115-01/085</b>	10101256
<b>MFD 32/03/065</b>	10102169
<b>MFD 32/03/090</b>	10102170

26.06.2026

Your Contact:

**WISKA Hoppmann GmbH**

Kisdorfer Weg 28 · 24568 Kaltenkirchen · Germany

☎ +49-4191-508-0 · 📠 +49-4191-508-209

contact@wiska.de · www.wiska.com



Your Contact:

**WISKA Hoppmann GmbH**

Kisdorfer Weg 28 · 24568 Kaltenkirchen · Germany

☎ +49-4191-508-0 · 📠 +49-4191-508-209

contact@wiska.de · www.wiska.com