

FFD 20/01/070-130

Sealing for flat cable

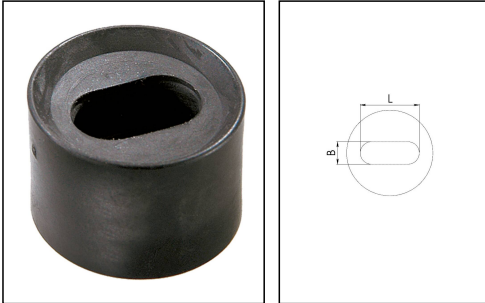

Products may differ in size, colour and appearance to those shown. If you require further information or customisation, please contact us directly.



Material	Thermoplastic elastomer
Temp. range min	-40 °C
Temp. range max	100 °C
Protection class	IP66
Colour	Black
Thickness flat cable B min	6 mm
Thickness flat cable B max	7 mm
Flat cable width L min	12,5 mm
Flat cable width L max	13 mm
Quantity of cable	1
Using for cable gland	SPRINT 20
Product Color	RAL 9005
Order no. RAL 9005	10101192
Type	FFD 20/01/070-130
Packing unit	25
EAN number	4007685014212
Tariff number	39269097
ETIM-Classification	EC000441

12.05.2026

Your Contact:

WISKA Hoppmann GmbH

Kisdorfer Weg 28 · 24568 Kaltenkirchen · Germany

☎ +49-4191-508-0 · 📠 +49-4191-508-209

contact@wiska.de · www.wiska.com

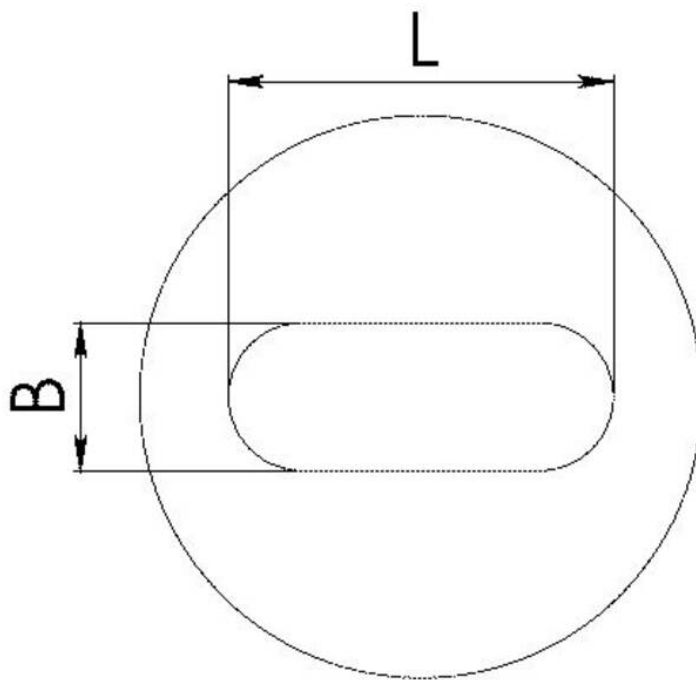

Your Contact:

WISKA Hoppmann GmbH

Kisdorfer Weg 28 · 24568 Kaltenkirchen · Germany

☎ +49-4191-508-0 · 📠 +49-4191-508-209

contact@wiska.de · www.wiska.com