

NSKV-RDE 1/2 BK

Cable gland with reduction sealing insert, polyamide, NPT 1/2", RAL 9005

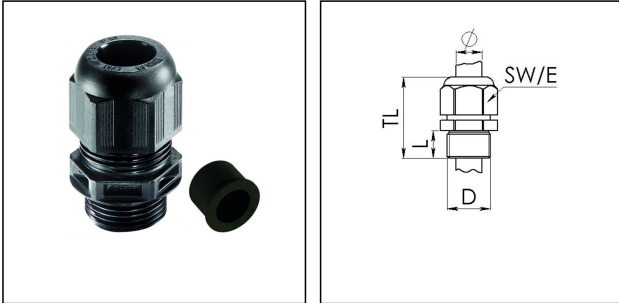

Products may differ in size, colour and appearance to those shown. If you require further information or customisation, please contact us directly.



Material cable gland	Polyamide
Material sealing gasket	EPDM
Protection class	IP68 (5 bar 30 min), IP69
Temp. range min	-40 °C
Temp. range max	100 °C
Glow wire test	750 °C
Thread type	NPT
Ø Connection thread D	1/2"
Length screw-in thread L	15 mm
Ø cable diameter min	4 mm
Ø cable diameter max	13 mm
Key width SW	24 mm
Collar diameter (E)	27 mm
Total length TL	42 mm - 51 mm
Type of cable anchorage	A
Install. torques fitting	4 N m
Install. torques cap nut	3 N m
Advice	With reduction insert
Product Color	RAL 9005
Type	NSKV-RDE 1/2 BK
Order no. RAL 9005	10101984
Packing unit	50
EAN number	4007685043151
Tariff number	39269097
ETIM-Classification	EC000441

Your Contact:

WISKA Hoppmann GmbH

Kisdorfer Weg 28 · 24568 Kaltenkirchen · Germany

☎ +49-4191-508-0 · 📠 +49-4191-508-209

contact@wiska.de · www.wiska.com

23.05.2026

Your Contact:
WISKA Hoppmann GmbH
Kisdorfer Weg 28 · 24568 Kaltenkirchen · Germany
☎ +49-4191-508-0 · 📠 +49-4191-508-209
contact@wiska.de · www.wiska.com



Your Contact:

WISKA Hoppmann GmbH

Kisdorfer Weg 28 · 24568 Kaltenkirchen · Germany

☎ +49-4191-508-0 · 📠 +49-4191-508-209

contact@wiska.de · www.wiska.com