

EMSKV 63 EMV-S

EMC-cable gland, brass nickel-plated with short thread, M63

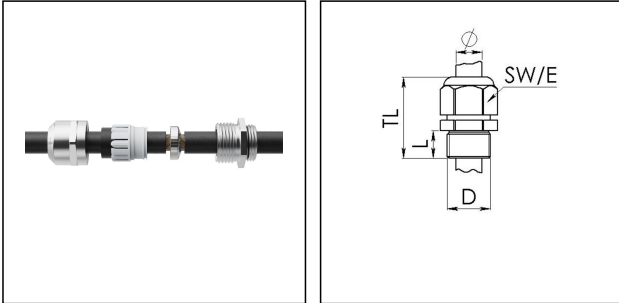

Products may differ in size, colour and appearance to those shown. If you require further information or customisation, please contact us directly.



Material cable gland	Brass nickel-plated
Material sealing gasket	EPDM
Material clamping cage	Polyamide
Material earthing insert	Stainless steel 1.4310
Temp. range min	-40 °C
Temp. range max	100 °C
Protection class	IP68 (5 bar 30 min), IP69
Thread type	M
Ø Connection thread D	63
Lead	1,5
Length screw-in thread L	10 mm
Ø cable diameter min	34 mm
Ø cable diameter max	48 mm
Cable Ø shield external	30 mm - 44 mm
Key width SW	68 mm
Collar diameter (E)	75 mm
Total length TL	56 mm - 67 mm
Type of cable anchorage	A
Install. torques cap nut	30 N m
Install. torques fitting	30 N m
Impact category	6
Surface	Nickel-plated
Order no. nickel-plated	10102280
Type	EMSKV 63 EMV-S
Packing unit	10

Your Contact:

WISKA Hoppmann GmbH

Kisdorfer Weg 28 · 24568 Kaltenkirchen · Germany

☎ +49-4191-508-0 · 📠 +49-4191-508-209

contact@wiska.de · www.wiska.com

Tariff number	85369010
EAN number	4007685046480
ETIM-Classification	EC000441

Recommended accessories

RDE 63	10062189
EMMU-EMV 63	10063217
BS 48	10064019

26.06.2026

Your Contact:

WISKA Hoppmann GmbH

Kisdorfer Weg 28 · 24568 Kaltenkirchen · Germany

☎ +49-4191-508-0 · 📠 +49-4191-508-209

contact@wiska.de · www.wiska.com



Your Contact:

WISKA Hoppmann GmbH

Kisdorfer Weg 28 · 24568 Kaltenkirchen · Germany

☎ +49-4191-508-0 · 📠 +49-4191-508-209

contact@wiska.de · www.wiska.com