

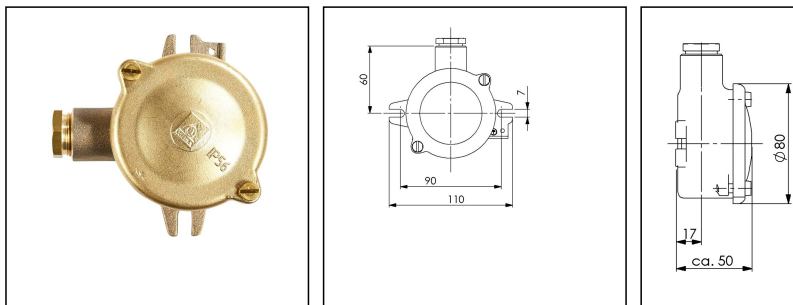

## 1149-1xZ12

HNA Junction box, brass



Products may differ in size, colour and appearance to those shown. If you require further information or customisation, please contact us directly.

<b>WISKA-Order no.</b>	10102392
<b>Type</b>	1149-1xZ12
<b>Voltage</b>	500 V
<b>Current</b>	16 A
<b>Protection class</b>	IP56
<b>Material</b>	Brass
<b>Material cable gland</b>	Brass
<b>Using for cable gland</b>	
<b>Type of cable</b>	armoured
<b>Ø cable diameter min</b>	10 mm
<b>Ø cable diameter max</b>	12,5 mm
<b>Type of cable gland</b>	M 24 x 1,5
<b>External dimensions LxWxH</b>	110x100x50mm
<b>Mounting</b>	Surface mounting
<b>Temp. range min</b>	-25 °C
<b>Temp. range max</b>	45 °C
<b>Rated cross section</b>	2,5 mm <sup>2</sup>
<b>Equipment</b>	Clamp
<b>Terminals/poles</b>	4-pole, 2,5 mm <sup>2</sup>
<b>Operational areas</b>	Indoor work space, Outdoor, Engine room
<b>Norm</b>	DIN 89250
<b>Weight</b>	0,6 kg
<b>Variations</b>	on request
<b>Tariff number</b>	85369010

Your Contact:

**WISKA Hoppmann GmbH**

Kisdorfer Weg 28 · 24568 Kaltenkirchen · Germany

☎ +49-4191-508-0 · 📠 +49-4191-508-209

contact@wiska.de · www.wiska.com

**Spare parts**

<b>SP-181/4 Terminal block</b>	22000352
<b>SP-HNA Cover sealing</b>	22000838

23.05.2026

Your Contact:

**WISKA Hoppmann GmbH**

Kisdorfer Weg 28 · 24568 Kaltenkirchen · Germany

☎ +49-4191-508-0 · 📠 +49-4191-508-209

contact@wiska.de · www.wiska.com

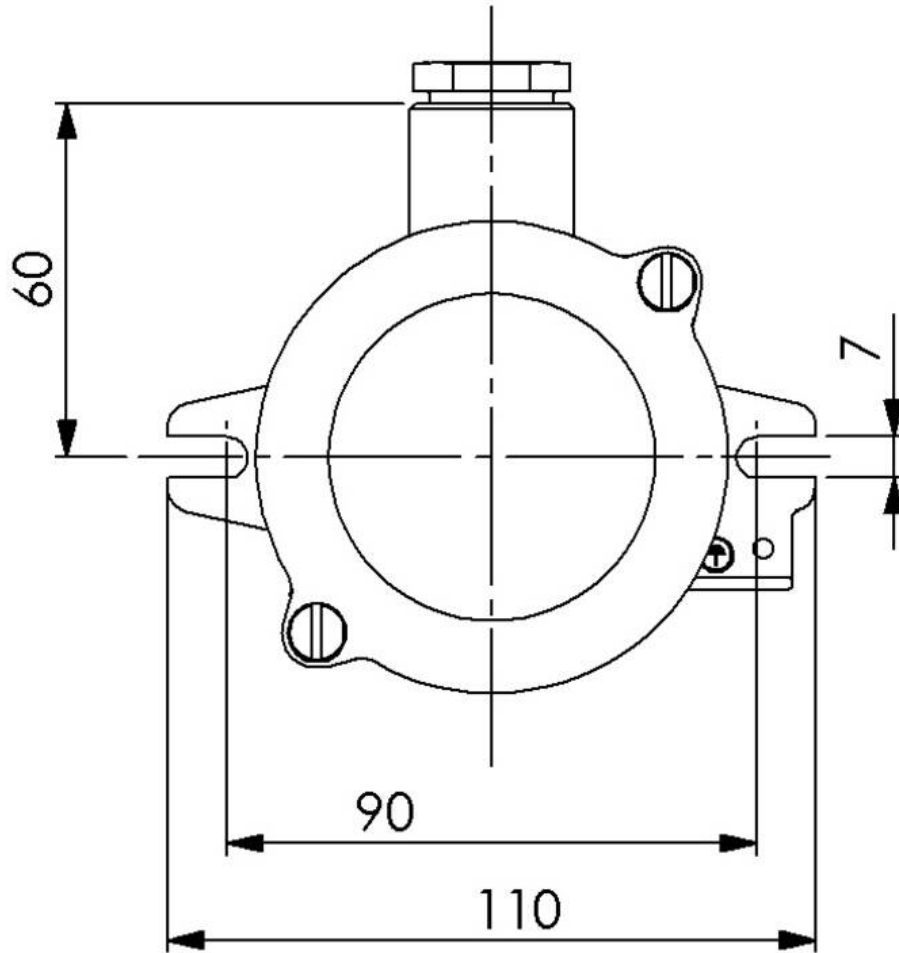

Your Contact:

**WISKA Hoppmann GmbH**

Kisdorfer Weg 28 · 24568 Kaltenkirchen · Germany

☎ +49-4191-508-0 · 📠 +49-4191-508-209

contact@wiska.de · www.wiska.com

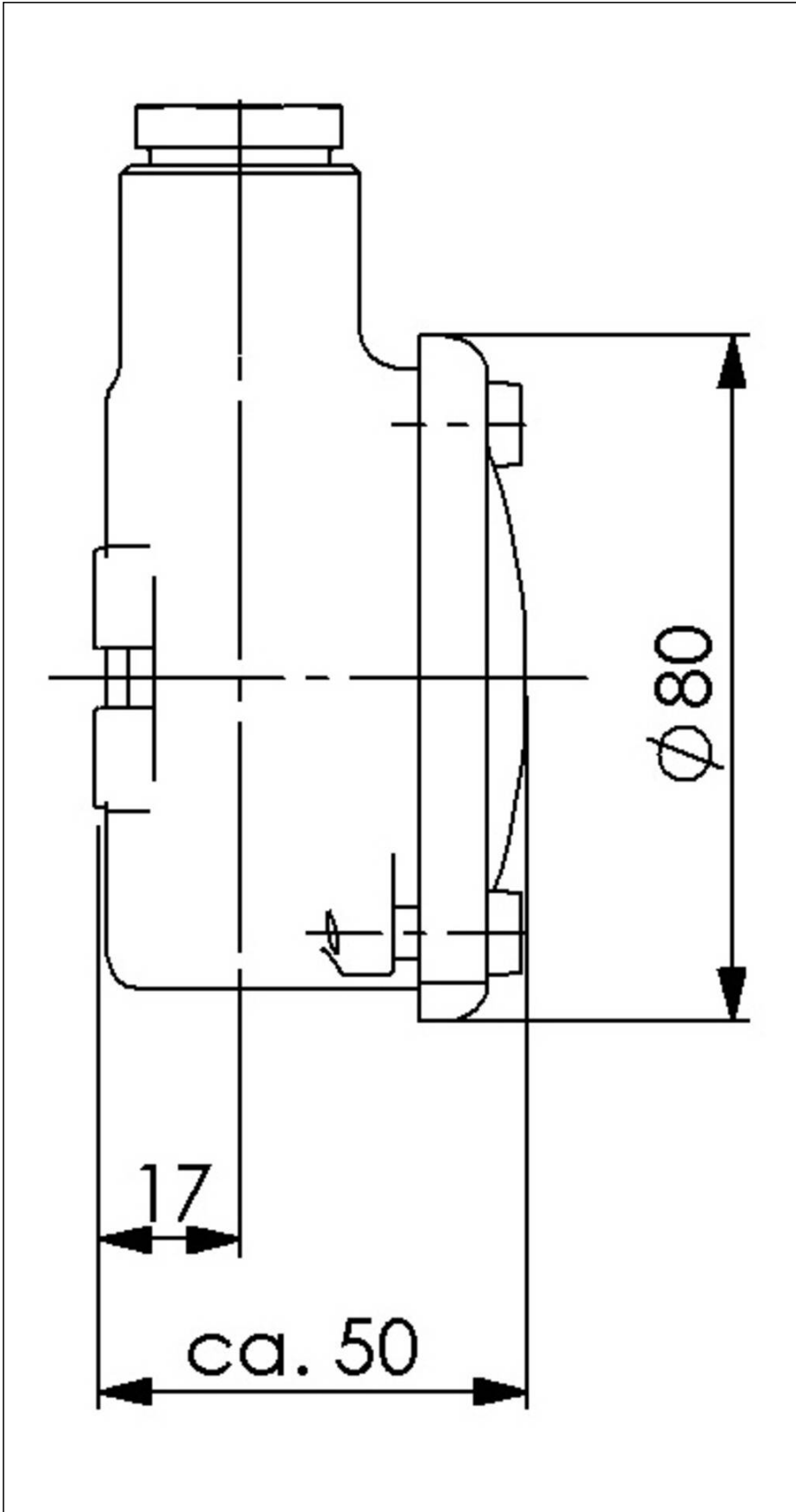

Your Contact:

**WISKA Hoppmann GmbH**

Kisdorfer Weg 28 · 24568 Kaltenkirchen · Germany

☎ +49-4191-508-0 · 📠 +49-4191-508-209

contact@wiska.de · www.wiska.com