

EMSKE 32 EMV-S

Ex-EMC cable gland with contact spring insert, brass nickel-plated, M32

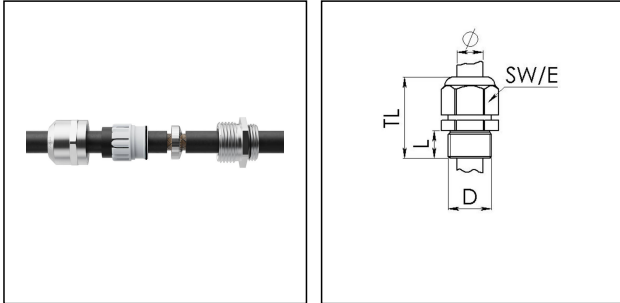

Products may differ in size, colour and appearance to those shown. If you require further information or customisation, please contact us directly.



| | |
|--------------------------------|----------------------------|
| Material cable gland | Brass nickel-plated |
| Material clamping cage | Polyamide |
| Material sealing gasket | EPDM |
| Material earthing insert | Stainless steel 1.4310 |
| Temp. range min | -40 °C |
| Temp. range max | 75 °C |
| Protection class | IP66 / IP68 (5 bar 30 min) |
| Type of protection | Ex tb, Ex eb |
| Ex-Certificate | ATEX, IECEx |
| Thread type | M |
| Ø Connection thread D | 32 |
| Lead | 1,5 |
| Length screw-in thread L | 8 mm |
| Ø cable diameter min | 13 mm |
| Ø cable diameter max | 21 mm |
| Ø cable below cable shield max | 20 mm |
| Key width SW | 36 mm |
| Collar diameter (E) | 40 mm |
| Total length TL | 36 mm - 44 mm |
| Install. torques fitting | 20 N m |
| Install. torques cap nut | 20 N m |
| Surface | Nickel-plated |
| Order no. nickel-plated | 10102975 |
| Type | EMSKE 32 EMV-S |
| Packing unit | 25 |

Your Contact:

WISKA Hoppmann GmbH

Kisdorfer Weg 28 · 24568 Kaltenkirchen · Germany

☎ +49-4191-508-0 · 📠 +49-4191-508-209

contact@wiska.de · www.wiska.com

| | |
|----------------------|---------------|
| Tariff number | 85369010 |
| EAN number | 4007685076081 |

Recommended accessories

| | |
|--------------------|----------|
| RDE 32 | 10062186 |
| EMMU-EMV 32 | 10063214 |
| BS 21 | 10064014 |

12.05.2026

Your Contact:
WISKA Hoppmann GmbH
Kisdorfer Weg 28 · 24568 Kaltenkirchen · Germany
☎ +49-4191-508-0 · 📠 +49-4191-508-209
contact@wiska.de · www.wiska.com



Your Contact:

WISKA Hoppmann GmbH

Kisdorfer Weg 28 · 24568 Kaltenkirchen · Germany

☎ +49-4191-508-0 · 📠 +49-4191-508-209

contact@wiska.de · www.wiska.com