

EMVPS 12

Pressure compensation plug, brass nickel-plated, M12

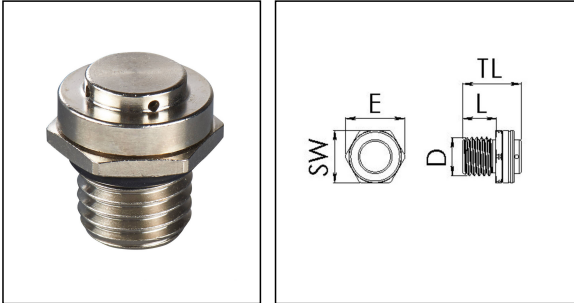

Products may differ in size, colour and appearance to those shown. If you require further information or customisation, please contact us directly.



Material cable gland	Brass nickel-plated
Material membrane	ePTFE
Material sealing gasket	EPDM
Airflow at 70mbar	22 l/h
Temp. range min	-40 °C
Temp. range max	100 °C
Protection class	IP68 / IP69
Thread type	M
Ø Connection thread D	12
Lead	1,5
Length screw-in thread L	10 mm
Key width SW	16 mm
Collar diameter (E)	18 mm
Tightening torque	2 N m
Total length TL	17,5 mm
Order no. nickel-plated	10103265
Type	EMVPS 12
Packing unit	10
EAN number	4007685081467
Tariff number	74198090
ETIM-Classification	EC000441

Recommended accessories

Your Contact:

WISKA Hoppmann GmbH

Kisdorfer Weg 28 · 24568 Kaltenkirchen · Germany

☎ +49-4191-508-0 · 📠 +49-4191-508-209

contact@wiska.de · www.wiska.com

23.05.2026

Your Contact:

WISKA Hoppmann GmbH

Kisdorfer Weg 28 · 24568 Kaltenkirchen · Germany

 +49-4191-508-0 ·  +49-4191-508-209

contact@wiska.de · www.wiska.com

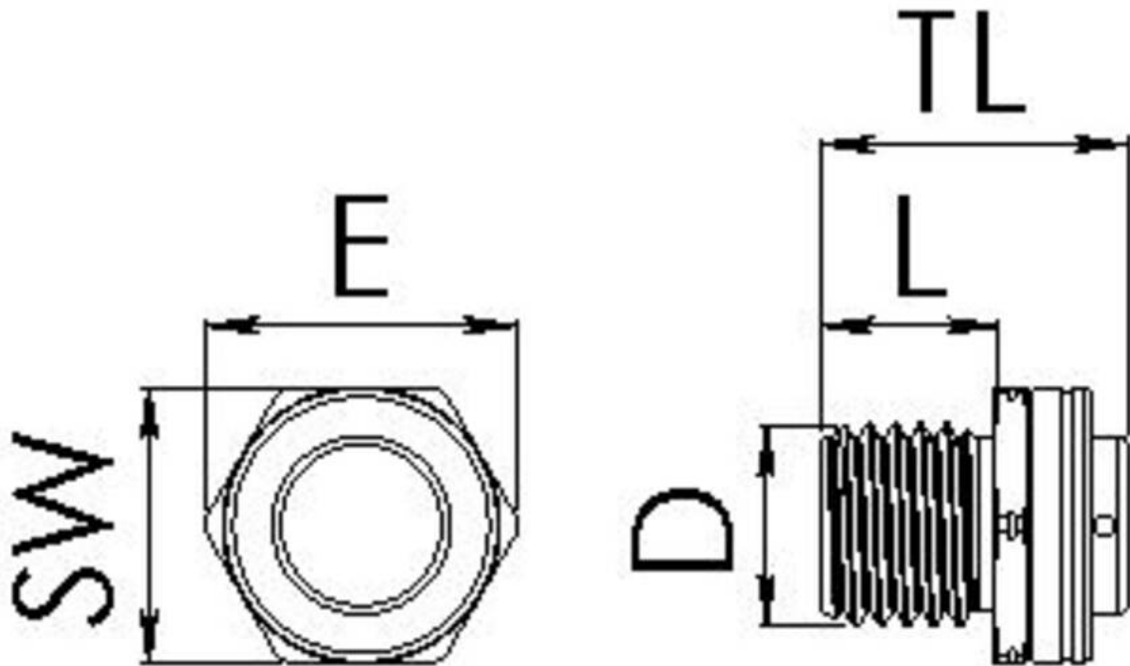

Your Contact:

WISKA Hoppmann GmbH

Kisdorfer Weg 28 · 24568 Kaltenkirchen · Germany

☎ +49-4191-508-0 · 📠 +49-4191-508-209

contact@wiska.de · www.wiska.com