

FFD 25/01/077-159

Sealing for flat cable

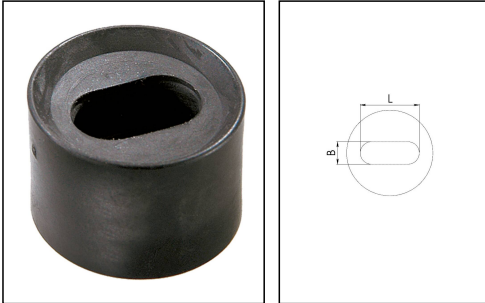

Products may differ in size, colour and appearance to those shown. If you require further information or customisation, please contact us directly.



Material	Thermoplastic elastomer
Temp. range min	-40 °C
Temp. range max	100 °C
Protection class	IP66
Colour	Black
Thickness flat cable B min	6,7 mm
Thickness flat cable B max	7,7 mm
Flat cable width L min	15,4 mm
Flat cable width L max	15,9 mm
Quantity of cable	1
Using for cable gland	SPRINT 25
Product Color	RAL 9005
Order no. RAL 9005	10103326
Type	FFD 25/01/077-159
Packing unit	25
EAN number	4007685082532
Tariff number	39269097
ETIM-Classification	EC000441

12.05.2026

Your Contact:
WISKA Hoppmann GmbH
 Kisdorfer Weg 28 · 24568 Kaltenkirchen · Germany
 ☎ +49-4191-508-0 · 📠 +49-4191-508-209
 contact@wiska.de · www.wiska.com

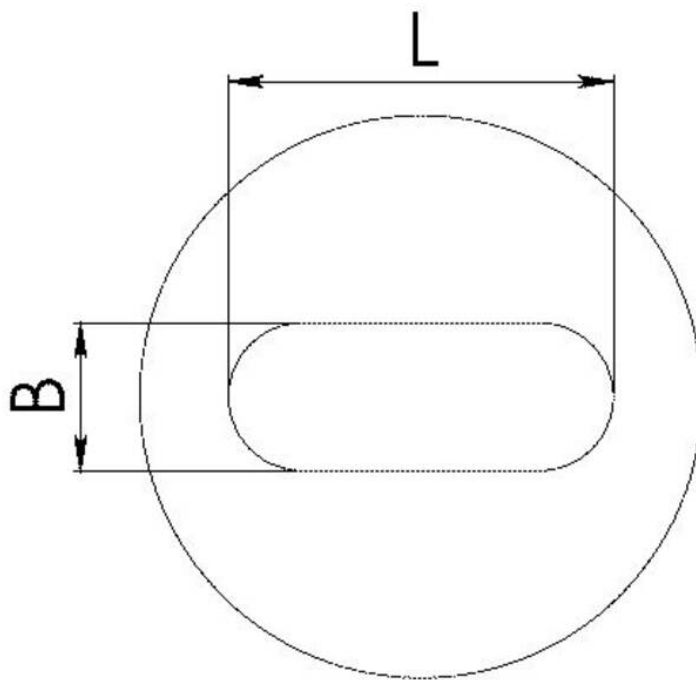

Your Contact:

WISKA Hoppmann GmbH

Kisdorfer Weg 28 · 24568 Kaltenkirchen · Germany

☎ +49-4191-508-0 · 📠 +49-4191-508-209

contact@wiska.de · www.wiska.com