

ESKE/1-L-e 50

Ex-cable gland, polyamide with long thread, RAL 9005, M50

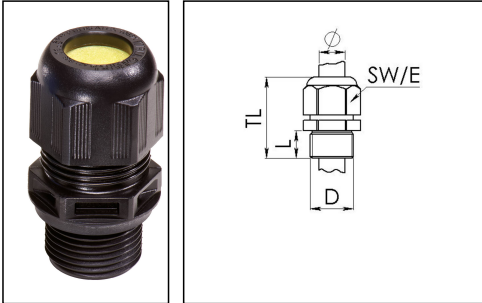

Products may differ in size, colour and appearance to those shown. If you require further information or customisation, please contact us directly.



Material cable gland	Polyamide
Material sealing gasket	EPDM
Temp. range min	-40 °C
Temp. range max	75 °C
Protection class	IP66 / IP68 (5 bar 30 min)
Type of protection	Ex eb, Ex tb
Ex-Certificate	IECEX, ATEX
Glow wire test	750 °C
Thread type	M
Ø Connection thread D	50
Lead	1,5
Length screw-in thread L	18 mm
Ø cable diameter min	23 mm
Ø cable diameter max	35 mm
Key width SW	55 mm
Collar diameter (E)	61 mm
Total length TL	63 mm - 76 mm
Install. torques fitting	13 N m
Install. torques cap nut	12 N m
Equipment	Incl. connection thread gasket
Product Color	RAL 9005
Order no. RAL 9005	10103385
Type	ESKE/1-L-e 50
Packing unit	4
EAN number	4007685083362

Your Contact:

WISKA Hoppmann GmbH

Kisdorfer Weg 28 · 24568 Kaltenkirchen · Germany

☎ +49-4191-508-0 · 📠 +49-4191-508-209

contact@wiska.de · www.wiska.com

Tariff number	39269097
ETIM-Classification	EC000441

Recommended accessories

EMUG 50 BK	10061786
RDE 50	10062188
BS 35	10064017

12.05.2026

Your Contact:

WISKA Hoppmann GmbH

Kisdorfer Weg 28 · 24568 Kaltenkirchen · Germany

☎ +49-4191-508-0 · 📠 +49-4191-508-209

contact@wiska.de · www.wiska.com



Your Contact:

WISKA Hoppmann GmbH

Kisdorfer Weg 28 · 24568 Kaltenkirchen · Germany

☎ +49-4191-508-0 · 📠 +49-4191-508-209

contact@wiska.de · www.wiska.com