

ESKE/1-L-e 63 LT

Ex-cable gland LowTemp, polyamide with long thread, RAL 9005, M63

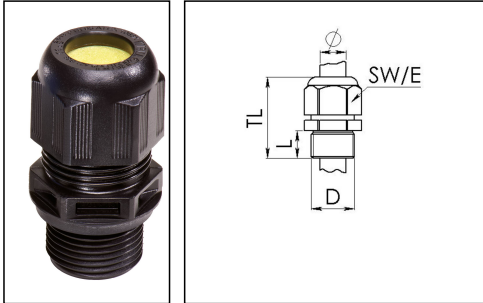

Products may differ in size, colour and appearance to those shown. If you require further information or customisation, please contact us directly.



Material cable gland	Polyamide
Material sealing gasket	Silicone
Temp. range min	-60 °C
Temp. range max	75 °C
Protection class	IP66 / IP68 (5 bar 30 min)
Type of protection	Ex eb, Ex tb
Ex-Certificate	IECEx, ATEX
Glow wire test	750 °C
Thread type	M
Ø Connection thread D	63
Lead	1,5
Length screw-in thread L	18 mm
Ø cable diameter min	34 mm
Ø cable diameter max	48 mm
Key width SW	68 mm
Collar diameter (E)	75 mm
Total length TL	67 mm - 81 mm
Install. torques fitting	17 N m
Install. torques cap nut	16 N m
Equipment	Incl. connection thread gasket
Product Color	RAL 9005
Order no. RAL 9005	10103452
Type	ESKE/1-L-e 63 LT
Packing unit	1
EAN number	4007685085205

Your Contact:

WISKA Hoppmann GmbH

Kisdorfer Weg 28 · 24568 Kaltenkirchen · Germany

☎ +49-4191-508-0 · 📠 +49-4191-508-209

contact@wiska.de · www.wiska.com

Tariff number	39269097
ETIM-Classification	EC000441

Recommended accessories

EMUG 63 BK	10061787
RDE 63 LT	10063967

12.05.2026

Your Contact:

WISKA Hoppmann GmbH

Kisdorfer Weg 28 · 24568 Kaltenkirchen · Germany

☎ +49-4191-508-0 · 📠 +49-4191-508-209

contact@wiska.de · www.wiska.com



Your Contact:

WISKA Hoppmann GmbH

Kisdorfer Weg 28 · 24568 Kaltenkirchen · Germany

☎ +49-4191-508-0 · 📠 +49-4191-508-209

contact@wiska.de · www.wiska.com