

EMSKV 20 RW

Railway cable gland, brass nickel-plated, with short thread, M20

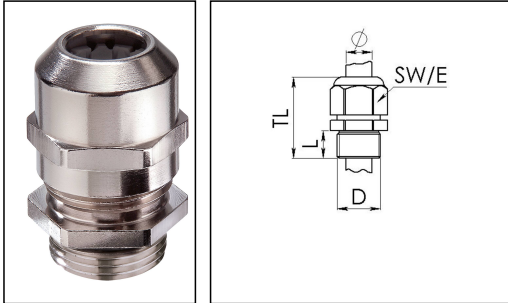

Products may differ in size, colour and appearance to those shown. If you require further information or customisation, please contact us directly.



Material cable gland	Brass nickel-plated
Material sealing gasket	EPDM
Material clamping cage	Polyamide UL94-V0
Hazard level EN acc. 45545	R22=HL3 / R23=HL3 / R24=HL3
Protection class	IP69, IP68 (5 bar 30 min)
Thread type	M
Ø Connection thread D	20
Lead	1,5
Length screw-in thread L	6 mm
Temp. range min	-40 °C
Temp. range max	100 °C
Ø cable diameter min	6 mm
Ø cable diameter max	13 mm
Key width SW	24 mm
Collar diameter (E)	27 mm
Total length TL	29 mm - 37 mm
Type of cable anchorage	A
Install. torques fitting	8 N m
Install. torques cap nut	8 N m
Impact category	6
Surface	Nickel-plated
Order no. nickel-plated	10104296
Type	EMSKV 20 RW
Packing unit	50
EAN number	4007686000177

Your Contact:

WISKA Hoppmann GmbH

Kisdorfer Weg 28 · 24568 Kaltenkirchen · Germany

☎ +49-4191-508-0 · 📠 +49-4191-508-209

contact@wiska.de · www.wiska.com

Tariff number	74198090
ETIM-Classification	EC000441

Remarks:

Meets fire protection standard EN 45545 and all requirements of Hazard Level 3 with fire resistance E30

Recommended accessories

EMMU 20	10063143
BS 13	10064010
RDE 20 RW	10105372
MFD 20/02/050 RW	10105931
MFD 20/03/040 RW	10105932

07.07.2026

Your Contact:

WISKA Hoppmann GmbH

Kisdorfer Weg 28 · 24568 Kaltenkirchen · Germany

☎ +49-4191-508-0 · 📠 +49-4191-508-209

contact@wiska.de · www.wiska.com



Your Contact:

WISKA Hoppmann GmbH

Kisdorfer Weg 28 · 24568 Kaltenkirchen · Germany

☎ +49-4191-508-0 · 📠 +49-4191-508-209

contact@wiska.de · www.wiska.com