

ESSKV 12 LT EMV-Z RW

EMC Railway cable gland LowTemp, stainless steel, M12

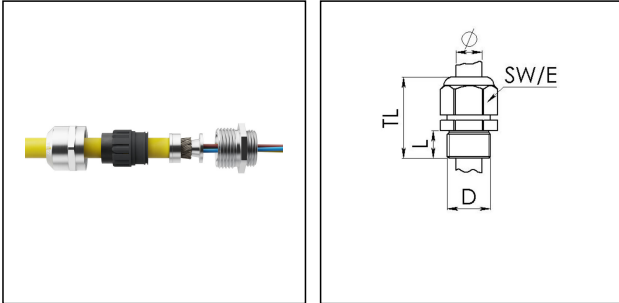

Products may differ in size, colour and appearance to those shown. If you require further information or customisation, please contact us directly.



Material cable gland	Stainless steel A2 (1.4305)
Material sealing gasket	Silicone
Material clamping cage	Polyamide UL94-V0
Material earthing insert	Brass plated
Hazard level EN acc. 45545	R22=HL3 / R23=HL3 / R24=HL3
Protection class	IP68 (5 bar 30 min), IP69
Thread type	M
Ø Connection thread D	12
Lead	1,5
Length screw-in thread L	5 mm
Temp. range min	-60 °C
Temp. range max	100 °C
Ø cable diameter min	3 mm
Ø cable diameter max	7 mm
Ø cable below cable shield max	5 mm
Key width SW	17 mm
Collar diameter (E)	19 mm
Total length TL	23 mm - 30 mm
Install. torques fitting	4 N m
Install. torques cap nut	4 N m
WISKA-Order no.	10105865
Type	ESSKV 12 LT EMV-Z RW
Packing unit	10
EAN number	4007686013276
Tariff number	73269098

Your Contact:

WISKA Hoppmann GmbH

Kisdorfer Weg 28 · 24568 Kaltenkirchen · Germany

☎ +49-4191-508-0 · 📠 +49-4191-508-209

contact@wiska.de · www.wiska.com

ETIM-Classification

EC000441

Recommended accessories

RDE 12 LT	10063981
BS 7	10064005
ESMU 12	10064188
ORD-S 12	10101757

26.06.2026

Your Contact:

WISKA Hoppmann GmbH

Kisdorfer Weg 28 · 24568 Kaltenkirchen · Germany

☎ +49-4191-508-0 · 📠 +49-4191-508-209

contact@wiska.de · www.wiska.com



Your Contact:

WISKA Hoppmann GmbH

Kisdorfer Weg 28 · 24568 Kaltenkirchen · Germany

☎ +49-4191-508-0 · 📠 +49-4191-508-209

contact@wiska.de · www.wiska.com