

ESSVG 20 LT RW

Railway pressure compensation cable gland, LowTemp, stainless steel, M20

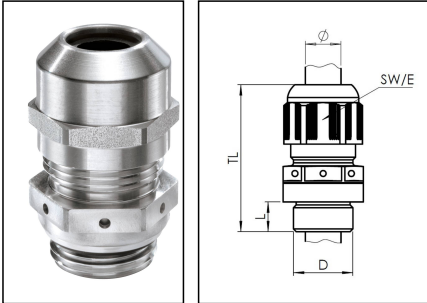

Products may differ in size, colour and appearance to those shown. If you require further information or customisation, please contact us directly.



Material cable gland	Edelstahl A2 (1.4305)
Material sealing gasket	Silicone
Material clamping cage	Polyamide UL94-V0
Material membrane	ePTFE
Airflow at 70mbar	55 l/h
Protection class	IP68
Thread type	M
Ø Connection thread D	20
Lead	1,5
Length screw-in thread L	6 mm
Temp. range min	-60 °C
Temp. range max	100 °C
Ø cable diameter min	6 mm
Ø cable diameter max	13 mm
Key width SW	24 mm
Collar diameter (E)	27 mm
Total length TL	41 mm - 50 mm
Install. torques fitting	8 N m
Install. torques cap nut	8 N m
WISKA-Order no.	10105909
Type	ESSVG 20 LT RW
Packing unit	1
EAN number	4007686013719
Tariff number	73269098
ETIM-Classification	EC000441

Your Contact:

WISKA Hoppmann GmbH

Kisdorfer Weg 28 · 24568 Kaltenkirchen · Germany

☎ +49-4191-508-0 · 📠 +49-4191-508-209

contact@wiska.de · www.wiska.com

Recommended accessories

RDE 20 LT	10063909
BS 13	10064010
ESMU 20	10064190
ORD-S 20	10101759

23.05.2026

Your Contact:

WISKA Hoppmann GmbH

Kisdorfer Weg 28 · 24568 Kaltenkirchen · Germany

☎ +49-4191-508-0 · 📠 +49-4191-508-209

contact@wiska.de · www.wiska.com



Your Contact:
WISKA Hoppmann GmbH
Kisdorfer Weg 28 · 24568 Kaltenkirchen · Germany
☎ +49-4191-508-0 · 📠 +49-4191-508-209
contact@wiska.de · www.wiska.com