

ESSKV 25 EMV-S RW

EMC Railway cable gland, stainless steel with short thread, M25

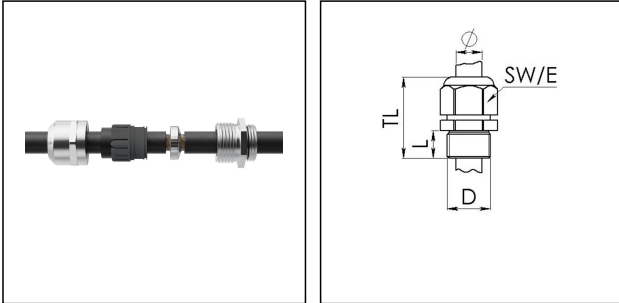

Products may differ in size, colour and appearance to those shown. If you require further information or customisation, please contact us directly.



Material cable gland	Stainless steel A2 (1.4305)
Material sealing gasket	EPDM
Material clamping cage	Polyamide UL94-V0
Material earthing insert	Stainless steel 1.4310
Hazard level EN acc. 45545	R22=HL3 / R23=HL3 / R24=HL3
Protection class	IP69, IP68 (5 bar 30 min)
Thread type	M
Ø Connection thread D	25
Lead	1,5
Length screw-in thread L	7 mm
Temp. range min	-40 °C
Temp. range max	100 °C
Ø cable diameter min	9 mm
Ø cable diameter max	17 mm
Ø cable below cable shield max	16 mm
Key width SW	30 mm
Collar diameter (E)	33 mm
Total length TL	33 mm - 42 mm
Install. torques fitting	10 N m
Install. torques cap nut	10 N m
WISKA-Order no.	10106140
Type	ESSKV 25 EMV-S RW
Packing unit	10
EAN number	4007686017168
Tariff number	73269098

Your Contact:

WISKA Hoppmann GmbH

Kisdorfer Weg 28 · 24568 Kaltenkirchen · Germany

☎ +49-4191-508-0 · 📠 +49-4191-508-209

contact@wiska.de · www.wiska.com

ETIM-Classification

EC000441

Recommended accessories

BS 17

10064012

23.05.2026

Your Contact:

WISKA Hoppmann GmbH

Kisdorfer Weg 28 · 24568 Kaltenkirchen · Germany

 +49-4191-508-0 ·  +49-4191-508-209

contact@wiska.de · www.wiska.com



Your Contact:

WISKA Hoppmann GmbH

Kisdorfer Weg 28 · 24568 Kaltenkirchen · Germany

☎ +49-4191-508-0 · 📠 +49-4191-508-209

contact@wiska.de · www.wiska.com