

EMBFS-17-20-BG

Conduit fitting, straight, plastic/brass nickel-plated, RAL 7031, NW 17 / M20

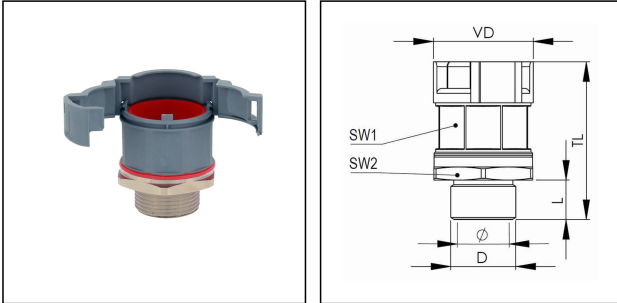

Products may differ in size, colour and appearance to those shown. If you require further information or customisation, please contact us directly.



Material Conduit fitting	polyamide UL94-V0
Material Connection thread	Brass nickel-plated
Material sealing gasket	TPU
Protection class	IP68, IP66
Temp. range min	-40 °C
Temp. range max	100 °C
Operational areas	EN 45545 - Railway
NW	17
Thread type	M
Ø Connection thread D	20
Lead	1,5
Length screw-in thread L	12 mm
Ø closure VD	33,2 mm
Ø inside	15,2 mm
Key width SW1	27 mm
Key width SW2	30 mm
Total length TL	48,9 mm
Type of conduit fitting	straight
UL 1696	Yes
Product Color	RAL 7031
Type	EMBFS-17-20-BG
Order no. RAL 7031	10106883
Packing unit	50
EAN number	4007686033571
Tariff number	74122000

Your Contact:

WISKA Hoppmann GmbH

Kisdorfer Weg 28 · 24568 Kaltenkirchen · Germany

☎ +49-4191-508-0 · 📠 +49-4191-508-209

contact@wiska.de · www.wiska.com

ETIM-Classification

EC001176

Remarks:

UL approval only in conjunction with UL approved corrugated conduits

Recommended accessories

EMMU 20	10063143
BCA-S-17-BG	10107082
BCAV-S-17-BG	10107099
BCIV-S-17-BG	10107115
BCA-17-D-BG	10107129
BCAV-17-D-BG	10107143
BCAB-L-17-BG	10109194
BCAV-H-17-BG	10109210
BCIB-H-17-BG	10109233

27.06.2026

Your Contact:

WISKA Hoppmann GmbH

Kisdorfer Weg 28 · 24568 Kaltenkirchen · Germany

☎ +49-4191-508-0 · 📠 +49-4191-508-209

contact@wiska.de · www.wiska.com

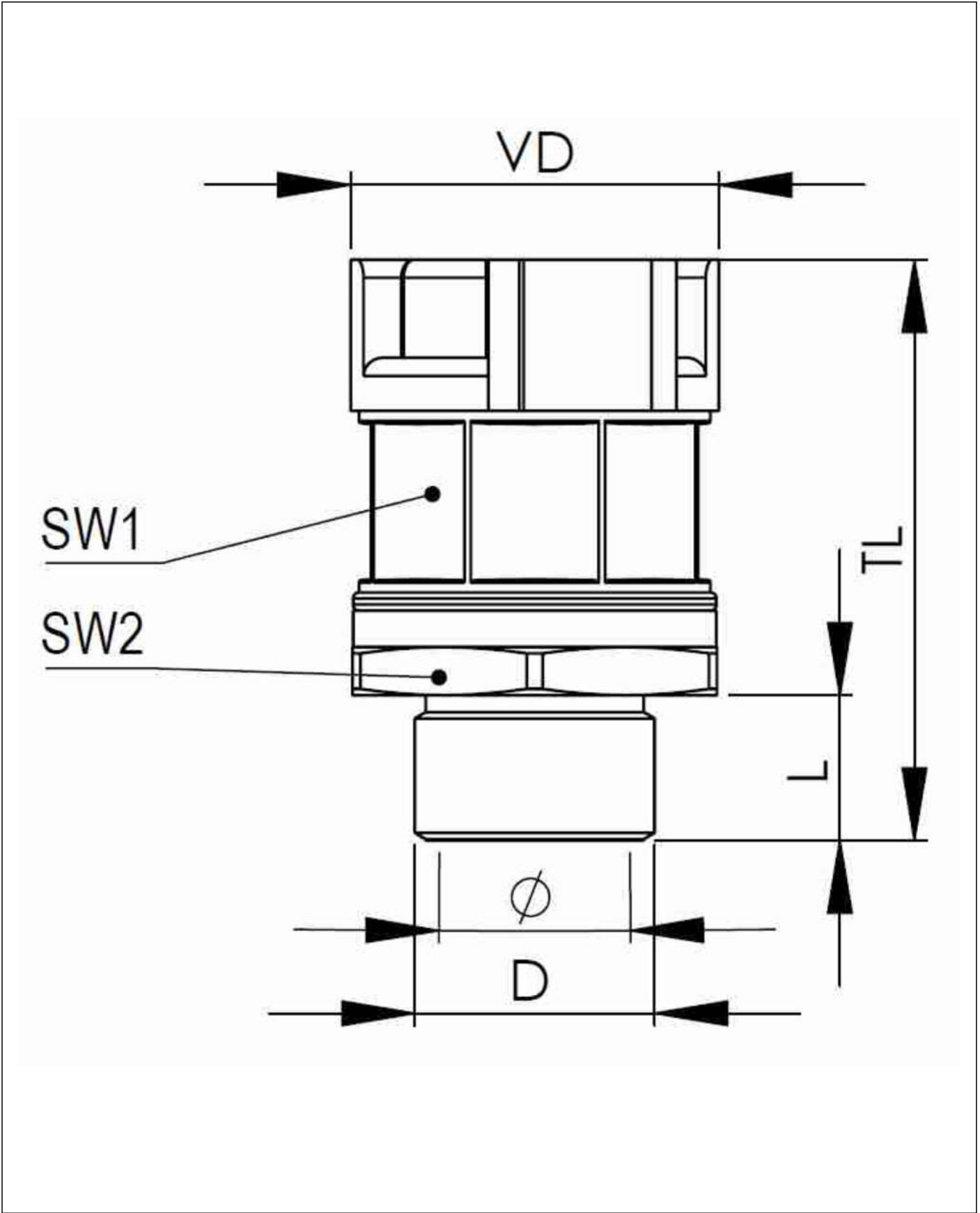

Your Contact:
WISKA Hoppmann GmbH
Kisdorfer Weg 28 · 24568 Kaltenkirchen · Germany
☎ +49-4191-508-0 · 📠 +49-4191-508-209
contact@wiska.de · www.wiska.com