

EMBFS-29-32-BG

Conduit fitting, straight, plastic/brass nickel-plated, RAL 7031, NW 29 / M32

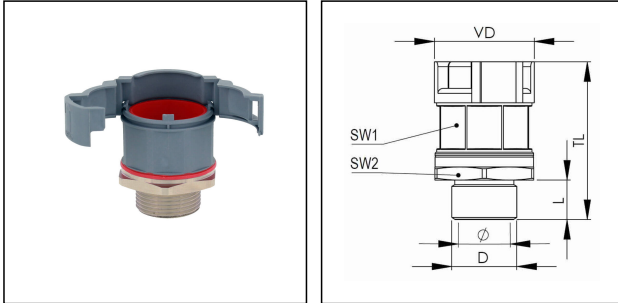

Products may differ in size, colour and appearance to those shown. If you require further information or customisation, please contact us directly.



Material Conduit fitting	polyamide UL94-V0
Material Connection thread	Brass nickel-plated
Material sealing gasket	TPU
Protection class	IP68, IP66
Temp. range min	-40 °C
Temp. range max	100 °C
Operational areas	EN 45545 - Railway
NW	29
Thread type	M
Ø Connection thread D	32
Lead	1,5
Length screw-in thread L	12 mm
Ø closure VD	46,7 mm
Ø inside	26 mm
Key width SW1	41 mm
Key width SW2	46 mm
Total length TL	59,5 mm
Type of conduit fitting	straight
UL 1696	Yes
Product Color	RAL 7031
Type	EMBFS-29-32-BG
Order no. RAL 7031	10106887
Packing unit	10
EAN number	4007686033656
Tariff number	74122000

Your Contact:

WISKA Hoppmann GmbH

Kisdorfer Weg 28 · 24568 Kaltenkirchen · Germany

☎ +49-4191-508-0 · 📠 +49-4191-508-209

contact@wiska.de · www.wiska.com

ETIM-Classification

EC001176

Remarks:

UL approval only in conjunction with UL approved corrugated conduits

Recommended accessories

EMMU 32	10063145
BCA-S-29-BG	10107084
BCAV-S-29-BG	10107101
BCIV-S-29-BG	10107117
BCA-29-D-BG	10107131
BCAV-29-D-BG	10107145
BCAB-L-29-BG	10109196
BCAV-H-29-BG	10109212
BCIB-H-29-BG	10109235

12.05.2026

Your Contact:

WISKA Hoppmann GmbH

Kisdorfer Weg 28 · 24568 Kaltenkirchen · Germany

☎ +49-4191-508-0 · 📠 +49-4191-508-209

contact@wiska.de · www.wiska.com



Your Contact:
WISKA Hoppmann GmbH
Kisdorfer Weg 28 · 24568 Kaltenkirchen · Germany
☎ +49-4191-508-0 · 📠 +49-4191-508-209
contact@wiska.de · www.wiska.com