

EMBFS-36-50-BK

Conduit fitting, straight, plastic/brass nickel-plated, RAL 9005, NW 36 / M50

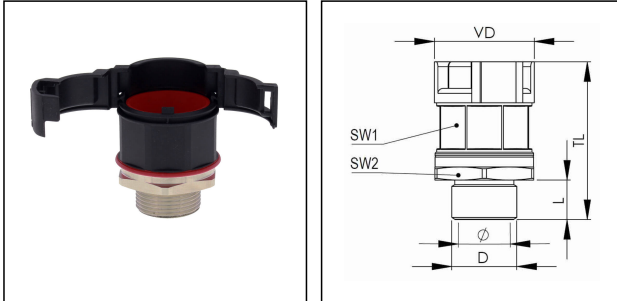

Products may differ in size, colour and appearance to those shown. If you require further information or customisation, please contact us directly.



Material Conduit fitting	polyamide UL94-V0
Material Connection thread	Brass nickel-plated
Material sealing gasket	TPU
Protection class	IP68, IP66
Temp. range min	-40 °C
Temp. range max	100 °C
Operational areas	EN 45545 - Railway
NW	36
Thread type	M
Ø Connection thread D	50
Lead	1,5
Length screw-in thread L	14 mm
Ø closure VD	55,7 mm
Ø inside	33,5 mm
Key width SW1	50 mm
Key width SW2	55 mm
Total length TL	62,2 mm
Type of conduit fitting	straight
UL 1696	Yes
Product Color	RAL 9005
Type	EMBFS-36-50-BK
Order no. RAL 9005	10106906
Packing unit	10
EAN number	4007686034011
Tariff number	74122000

Your Contact:

WISKA Hoppmann GmbH

Kisdorfer Weg 28 · 24568 Kaltenkirchen · Germany

☎ +49-4191-508-0 · 📠 +49-4191-508-209

contact@wiska.de · www.wiska.com

ETIM-Classification

EC001176

Remarks:

UL approval only in conjunction with UL approved corrugated conduits

Recommended accessories

EMMU 50	10063147
BCA-S-36-BK	10107078
BCAV-S-36-BK	10107093
BCIV-S-36-BK	10107110
BCA-36-D-BK	10107125
BCAV-36-D-BK	10107139
BCAB-L-36-BK	10109188
BCAV-H-36-BK	10109205
BCIB-H-36-BK	10109227

23.05.2026

Your Contact:

WISKA Hoppmann GmbH

Kisdorfer Weg 28 · 24568 Kaltenkirchen · Germany

☎ +49-4191-508-0 · 📠 +49-4191-508-209

contact@wiska.de · www.wiska.com

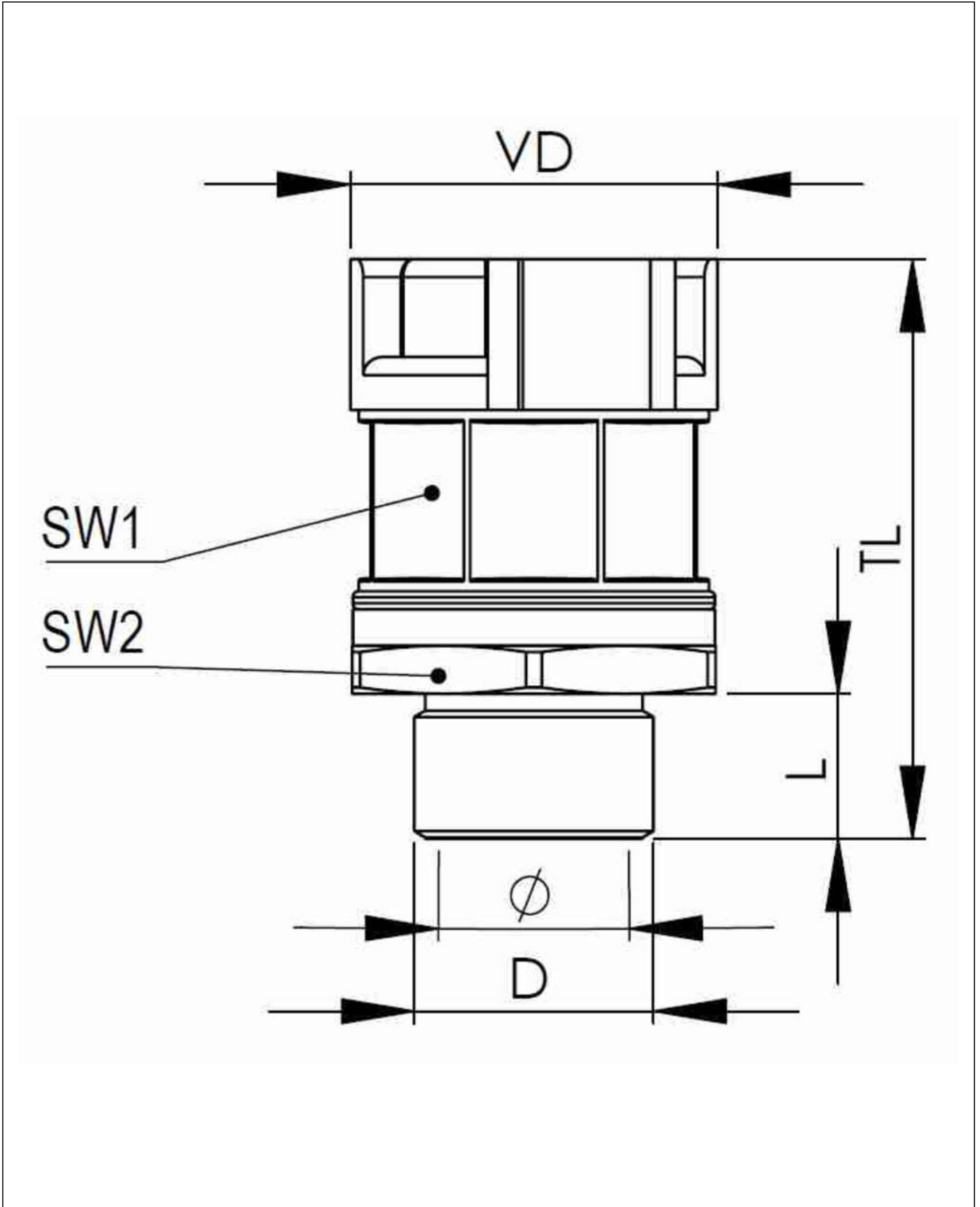

Your Contact:

WISKA Hoppmann GmbH

Kisdorfer Weg 28 · 24568 Kaltenkirchen · Germany

☎ +49-4191-508-0 · 📠 +49-4191-508-209

contact@wiska.de · www.wiska.com