

EMBFSI-17-20-BK

Conduit fitting, internal thread, plastic/brass nickel-plated, RAL 9005, NW17

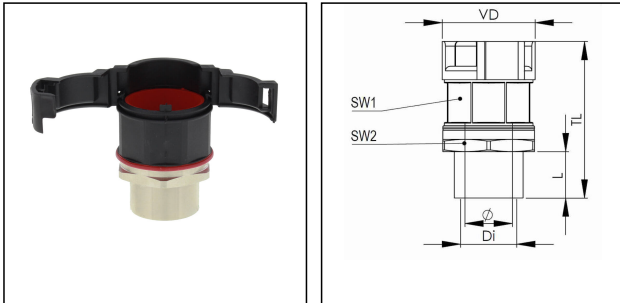

Products may differ in size, colour and appearance to those shown. If you require further information or customisation, please contact us directly.



Material Conduit fitting	polyamide UL94-V0
Material Connection thread	Brass nickel-plated
Material sealing gasket	TPU
Protection class	IP68, IP66
Temp. range min	-40 °C
Temp. range max	100 °C
Operational areas	EN 45545 - Railway
NW	17
Thread type	M
Ø Connection thread D	20
Lead	1,5
Length screw-in thread L	14,5 mm
Ø closure VD	33,2 mm
Ø inside	15,4 mm
Key width SW1	27 mm
Key width SW2	30 mm
Total length TL	51,4 mm
Type of conduit fitting	straight
UL 1696	Yes
Product Color	RAL 9005
Type	EMBFSI-17-20-BK
Order no. RAL 9005	10106925
Packing unit	50
EAN number	4007686034387
Tariff number	74122000

Your Contact:

WISKA Hoppmann GmbH

Kisdorfer Weg 28 · 24568 Kaltenkirchen · Germany

☎ +49-4191-508-0 · 📠 +49-4191-508-209

contact@wiska.de · www.wiska.com

ETIM-Classification

EC001176

Remarks:

UL approval only in conjunction with UL approved corrugated conduits

Recommended accessories

BCA-S-17-BK	10107075
BCAV-S-17-BK	10107090
BCIV-S-17-BK	10107107
BCA-17-D-BK	10107122
BCAV-17-D-BK	10107136
BCAB-L-17-BK	10109185
BCAV-H-17-BK	10109202
BCIB-H-17-BK	10109224

23.05.2026

Your Contact:

WISKA Hoppmann GmbH

Kisdorfer Weg 28 · 24568 Kaltenkirchen · Germany

☎ +49-4191-508-0 · 📠 +49-4191-508-209

contact@wiska.de · www.wiska.com

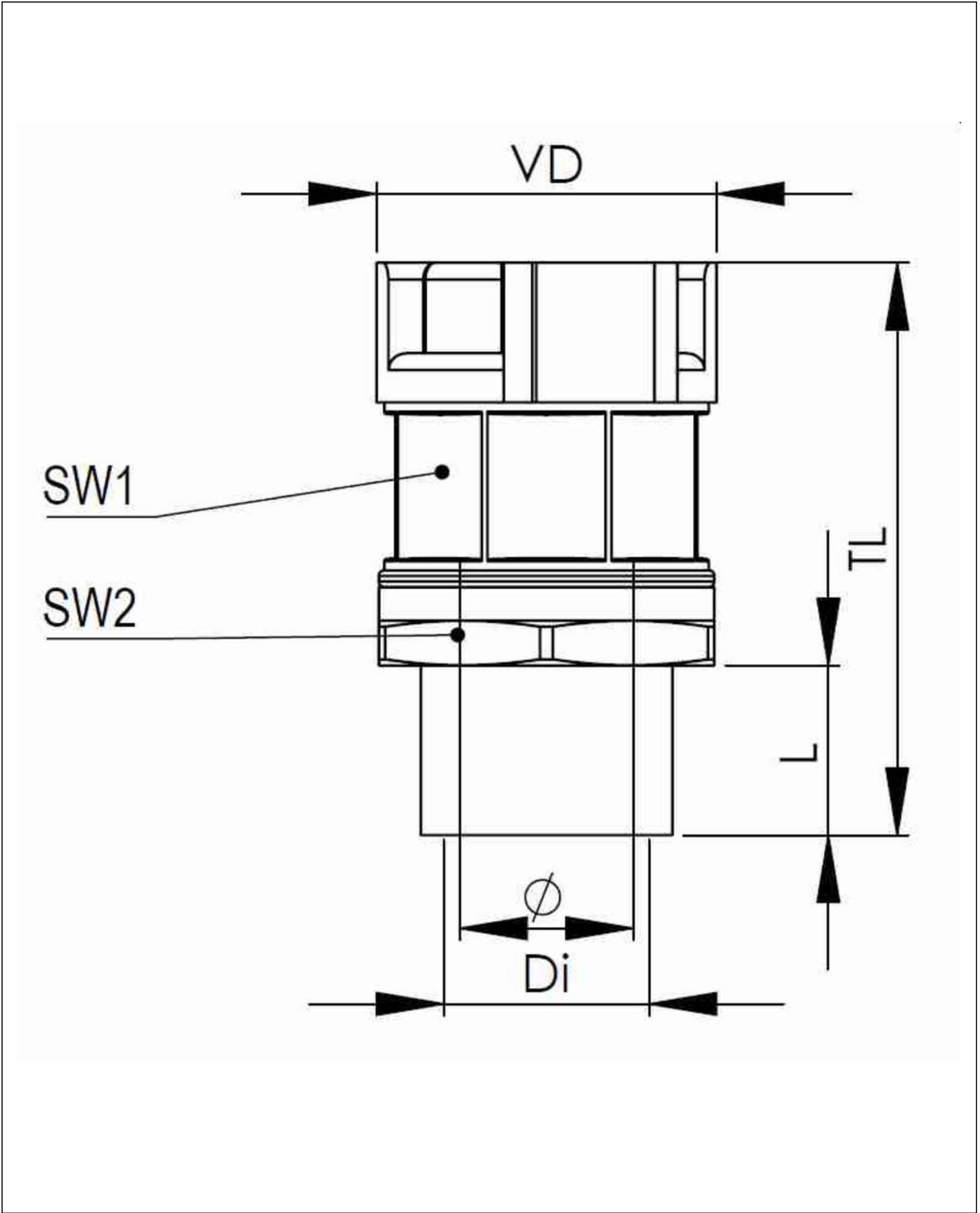

Your Contact:
WISKA Hoppmann GmbH
Kisdorfer Weg 28 · 24568 Kaltenkirchen · Germany
☎ +49-4191-508-0 · 📠 +49-4191-508-209
contact@wiska.de · www.wiska.com