

EMBF45-10-16-BG

Conduit fitting, 45° angle, plastic/brass, RAL 7031, NW 10 / M16

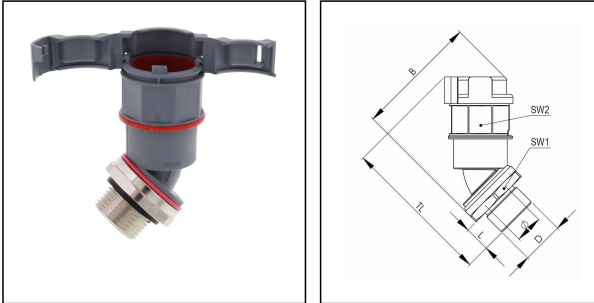

Products may differ in size, colour and appearance to those shown. If you require further information or customisation, please contact us directly.



Material Conduit fitting	polyamide UL94-V0
Material Connection thread	Brass nickel-plated
Material sealing gasket	TPU
Protection class	IP66, IP68
Temp. range min	-40 °C
Temp. range max	100 °C
Operational areas	EN 45545 - Railway
NW	10
Thread type	M
Ø Connection thread D	16
Lead	1,5
Length screw-in thread L	12 mm
Ø inside	7 mm
Key width SW1	22 mm
Key width SW2	20 mm
Width B	50,5 mm
Total length TL	62,1 mm
Type of conduit fitting	45° Angle
UL 1696	Yes
Product Color	RAL 7031
Type	EMBF45-10-16-BG
Order no. RAL 7031	10106984
Packing unit	50
EAN number	4007686035575
Tariff number	74122000

Your Contact:

WISKA Hoppmann GmbH

Kisdorfer Weg 28 · 24568 Kaltenkirchen · Germany

☎ +49-4191-508-0 · 📠 +49-4191-508-209

contact@wiska.de · www.wiska.com

ETIM-Classification

EC001176

Remarks:

UL approval only in conjunction with UL approved corrugated conduits

Recommended accessories

EMMU 16	10063142
BCA-S-10-BG	10107079
BCAV-S-10-BG	10107096
BCIV-S-10-BG	10107112
BCA-10-D-BG	10107127
BCAV-10-D-BG	10107141
BCAB-L-10-BG	10109191
BCAV-H-10-BG	10109208
BCIB-H-10-BG	10109230

12.05.2026

Your Contact:

WISKA Hoppmann GmbH

Kisdorfer Weg 28 · 24568 Kaltenkirchen · Germany

☎ +49-4191-508-0 · 📠 +49-4191-508-209

contact@wiska.de · www.wiska.com

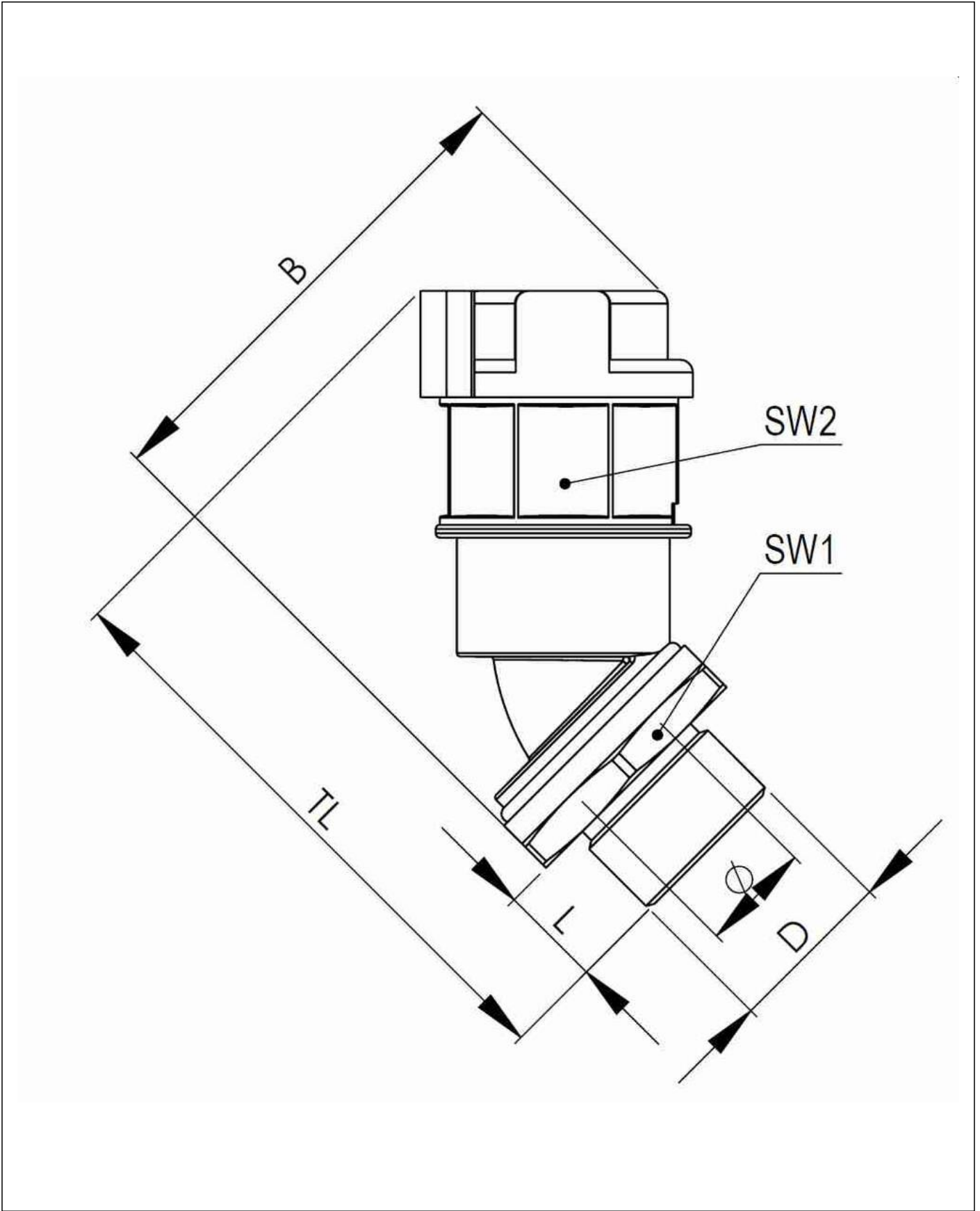

Your Contact:
WISKA Hoppmann GmbH
Kisdorfer Weg 28 · 24568 Kaltenkirchen · Germany
☎ +49-4191-508-0 · 📠 +49-4191-508-209
contact@wiska.de · www.wiska.com