

EMBF90I-36-40-BK

Conduit fitting, internal thread, 90° angle, brass

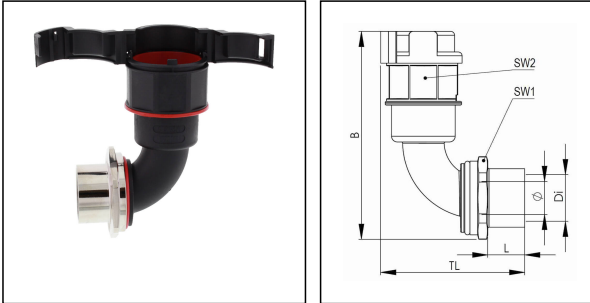

Products may differ in size, colour and appearance to those shown. If you require further information or customisation, please contact us directly.



Material Conduit fitting	polyamide UL94-V0
Material Connection thread	Brass nickel-plated
Material sealing gasket	TPU
Protection class	IP68, IP66
Temp. range min	-40 °C
Temp. range max	100 °C
Operational areas	EN 45545 - Railway
NW	36
Thread type	M
Ø Connection thread D	40
Lead	1,5
Length screw-in thread L	13 mm
Ø inside	33 mm
Key width SW1	55 mm
Key width SW2	50 mm
Width B	120,8 mm
Total length TL	85,2 mm
Type of conduit fitting	90° Angle
UL 1696	Yes
Product Color	RAL 9005
Type	EMBF90I-36-40-BK
Order no. RAL 9005	10107369
Packing unit	10
EAN number	4007686042528
Tariff number	74122000

Your Contact:

WISKA Hoppmann GmbH

Kisdorfer Weg 28 · 24568 Kaltenkirchen · Germany

☎ +49-4191-508-0 · 📠 +49-4191-508-209

contact@wiska.de · www.wiska.com

ETIM-Classification

EC001176

Remarks:

UL approval only in conjunction with UL approved corrugated conduits

Recommended accessories

BCA-S-36-BK	10107078
BCAV-S-36-BK	10107093
BCIV-S-36-BK	10107110
BCA-36-D-BK	10107125
BCAV-36-D-BK	10107139
BCAB-L-36-BK	10109188
BCAV-H-36-BK	10109205
BCIB-H-36-BK	10109227

23.05.2026

Your Contact:

WISKA Hoppmann GmbH

Kisdorfer Weg 28 · 24568 Kaltenkirchen · Germany

☎ +49-4191-508-0 · 📠 +49-4191-508-209

contact@wiska.de · www.wiska.com



Your Contact:

WISKA Hoppmann GmbH

Kisdorfer Weg 28 · 24568 Kaltenkirchen · Germany

☎ +49-4191-508-0 · 📠 +49-4191-508-209

contact@wiska.de · www.wiska.com