

EMBFSCG-12-20-BK

Conduit fitting with cable gland, straight, plastic/brass, RAL 9005, NW12

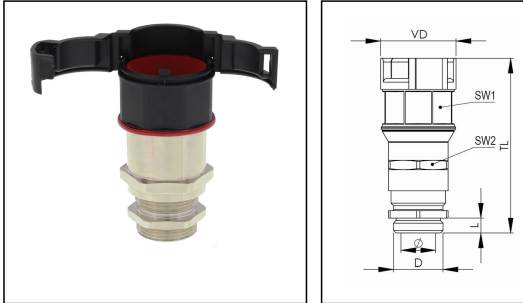

Products may differ in size, colour and appearance to those shown. If you require further information or customisation, please contact us directly.



Material Conduit fitting	polyamide UL94-V0
Material Connection thread	Brass nickel-plated
Material sealing gasket	TPU
Protection class	IP68, IP66
Temp. range min	-40 °C
Temp. range max	100 °C
Operational areas	EN 45545 - Railway
NW	12
Thread type	M
Ø Connection thread D	20
Lead	1,5
Length screw-in thread L	6 mm
Ø cable diameter min	6 mm
Ø cable diameter max	10 mm
Ø closure VD	27,3 mm
Ø inside	10 mm
Key width SW1	22 mm
Key width SW2	24 mm
Total length TL	63,7 mm - 64 mm
Type of conduit fitting	straight
Product Color	RAL 9005
Type	EMBFSCG-12-20-BK
Order no. RAL 9005	10107381
Packing unit	50
EAN number	4007686042801

Your Contact:

WISKA Hoppmann GmbH

Kisdorfer Weg 28 · 24568 Kaltenkirchen · Germany

☎ +49-4191-508-0 · 📠 +49-4191-508-209

contact@wiska.de · www.wiska.com

Tariff number	74122000
ETIM-Classification	EC001176

Recommended accessories

EMMU 20	10063143
BCA-S-12-BK	10107073
BCAV-S-12-BK	10107088
BCIV-S-12-BK	10107105
BCAB-L-12-BK	10109183
BCAV-H-12-BK	10109201
BCIB-H-12-BK	10109222

23.05.2026

Your Contact:

WISKA Hoppmann GmbH

Kisdorfer Weg 28 · 24568 Kaltenkirchen · Germany

☎ +49-4191-508-0 · 📠 +49-4191-508-209

contact@wiska.de · www.wiska.com

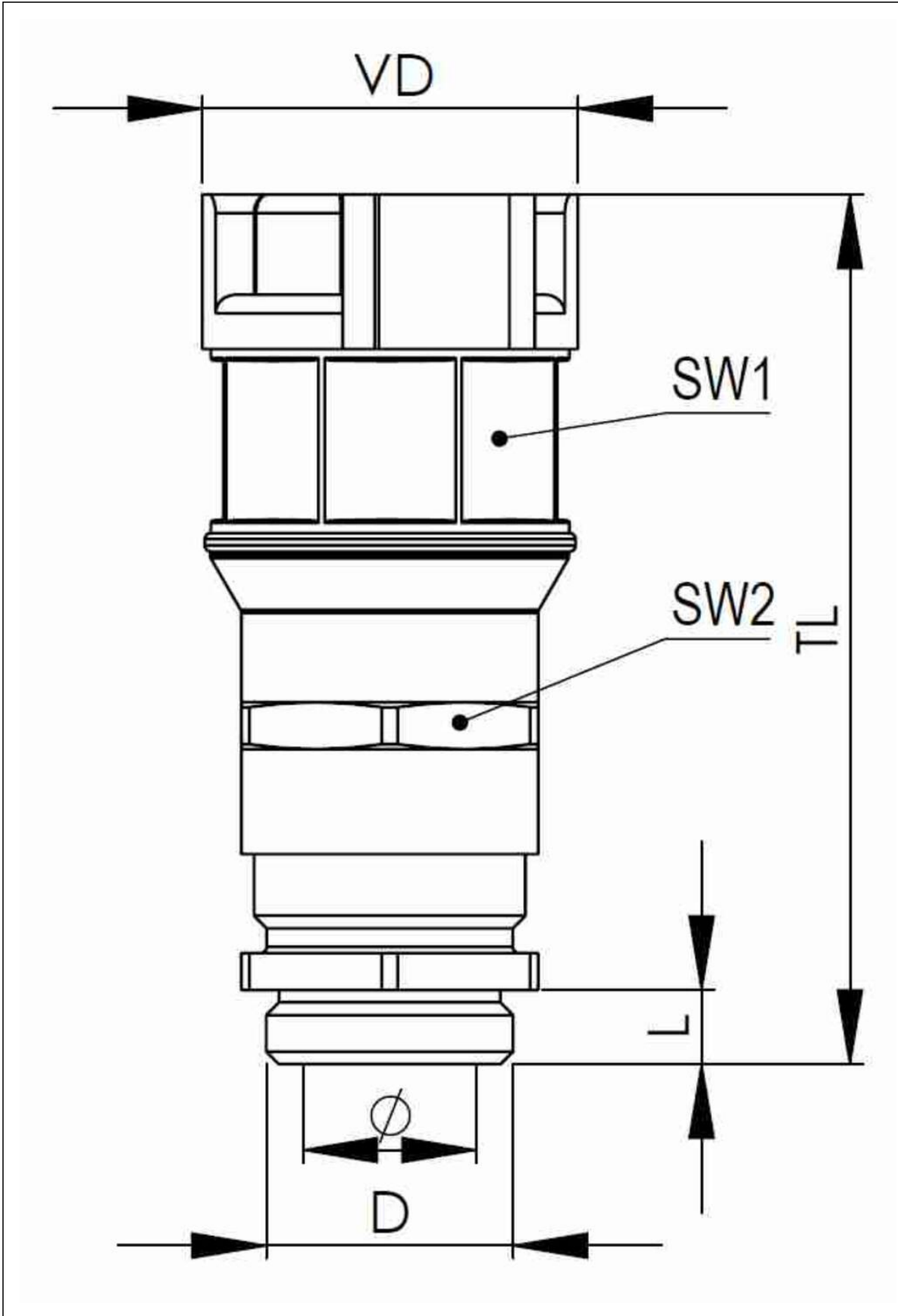

Your Contact:

WISKA Hoppmann GmbH

Kisdorfer Weg 28 · 24568 Kaltenkirchen · Germany

☎ +49-4191-508-0 · 📠 +49-4191-508-209

contact@wiska.de · www.wiska.com